

2004 MOUNTAIN AIRE
CLASS A / DIESEL PUSHER BY NEWMAR



2004 MOUNTAIN AIRE

CLASS A / DIESEL PUSHER BY NEWMAR

DESTINATION:

New England, Early Fall



NEWMARCORP.COM

Here, vivid autumn colors match America's red, white and blue.

It's not always a matter of reconciling tradition with revolutionary ideas or practicality with artistry. More often than not, it's about finding a balance. You'll see that in history. And you'll see it in Newmar's 2004 Mountain Aire Class A and Diesel Pusher motorhomes: in the chassis and power options...the numerous luxury features, including this year's expanded interior space...and the exterior's gorgeous Full-Paint Masterpiece Finish,[™] standard on both coaches. With Mountain Aire, Newmar's designers and engineers have reinterpreted classic design elements in innovative ways. The result is both contemporary... and timeless.





MADP 430I/Antelope



MACA 350I/Royal Blue

B

- A. Generous cabinets and Corian® countertop space, plus an open, airy layout, make this diesel pusher kitchen a model of convenience.
- B. A handy flip-up/flip-down countertop extension increases work space, and the stove top's sealed burners clean easily, since they don't trap food.
- C. This plush, accommodating, family-style U-dinette makes a wonderful setting for meals, conversation or gaming.
- D. A more intimate setting for a snack or a cup of coffee and small talk is provided by this model's living-area dinette with freestanding chairs.



C

MADP 4018/Raw Silk



D

MACA 410I/Verde

Took the Freedom Trail Walking Tour through Boston's famous Revolutionary War sites, including Boston Common, the Paul Revere House and the Old North Church.





MADP 4018/Raw Silk



B

- A. The living room slideout opens up floor space in this year's already larger interior. Notice also the elegant window treatments and the double U-sofa/dinette combination with pullout storage drawers in the base. For even more comfort and utility, the sofa includes an incliner and can serve as an extra bed.
- B. This newly designed diesel pusher dashboard, with its easily accessible controls and gauges, puts you in firm command of the road.
- C. An extra touch of beauty and sophistication is provided by this model's sculpted carpet.
- D. A Sony® color TV with a 32" plasma flat-screen is optional in this living-room entertainment center.



C



D

MADP 4016/Verde

OCTOBER 5 ~

Visited Gene's brother and his family in Lowell, Mass., America's first big industrial city. The woods surrounding the cabals were blazing with reds, oranges and yellows!



A

MACA 4018/Raw Silk



B

MACA 4016/Verde



MADP 430I/Antelope

C

- A. The Mountain Aire bedroom is notable for its plentiful cabinets, room-expanding mirrors, comfortable bedding and designer headboard.
- B. Featured in the private bathroom is a generous vanity, a mirrored medicine cabinet and a fiberglass shower surround with a decorative door.
- C. This model is graced with an attractive window seat on a cabinet base featuring two storage drawers.
- D. Standard in the bedroom is this advanced 19" Sony® flat-screen color TV with its own built-in cabinet shelf.
- E. This rearview monitor in the cockpit clearly lets you see what's going on behind your coach during backup maneuvers.



D



E

NEWMAR'S FREEDOM WARRANTY™

Your Mountain Aire Class A or Diesel Pusher Motorhome is built to take you as far as your road rolls on... for as long as you roll on with it. Because there's more than enough solid engineering here to ensure years of travel pleasure.

Mountain Aire is assembled on the same production line, to the same exacting standards and with the same meticulous care, as all Newmar motorhomes. It also embodies Newmar's long history of product innovation and industry "firsts." For us, it's a matter of pride. And tradition. Of taking personal responsibility and building a product that each of us, ourselves, would want to own.

As proof of our commitment, we back every motorhome we make with a three-year/36,000-mile (Class A) and 50,000-mile (Diesel Pusher), bumper-to-bumper limited warranty: The Newmar Freedom Warranty. Ask your dealer for details. You're sure to find coverage this comprehensive a truly liberating experience.

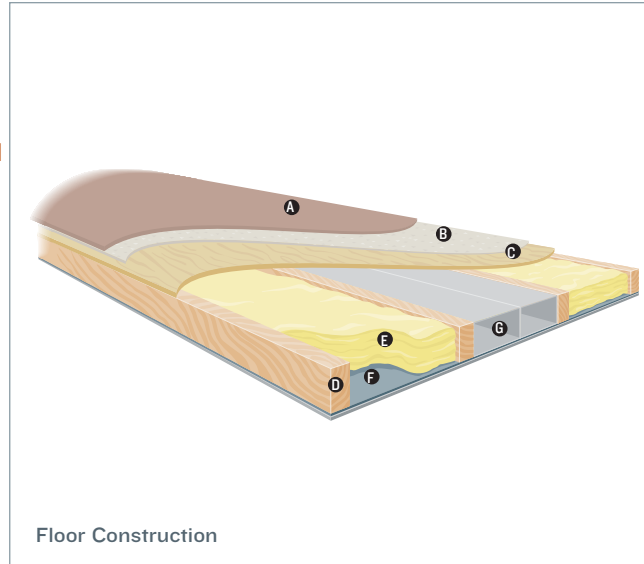

Floor Construction

- A. Plush carpet*
- B. Carpet padding
- C. 5/8" floor decking
- D. 2" x 3" wood stringer
- E. Fiberglass batten insulation
- F. Polyethylene moisture barrier
- G. In-floor heating ducts

*Ceramic tile, simulated floor and simulated tile options also available.

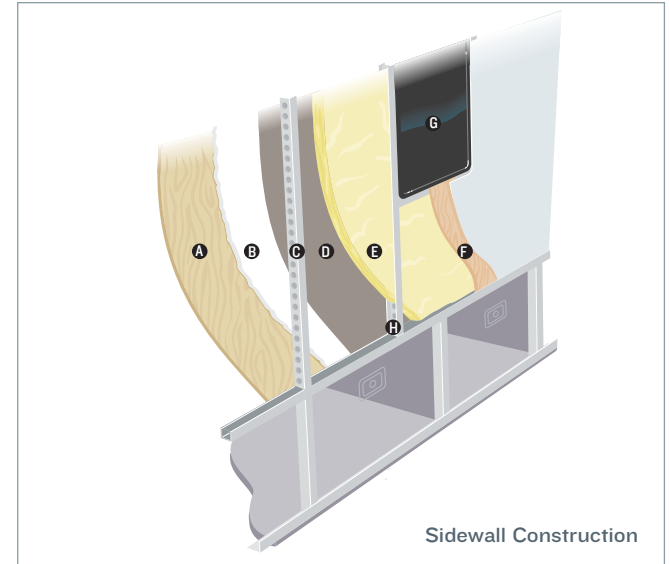

Sidewall Construction

- A. Plywood interior wallboard
- B. 5/8" bead foam
- C. 1.5" C-channel aluminum studs with punched holes
- D. Kraft paper vapor barrier
- E. Fiberglass insulation
- F. Composite one-piece gel coat exterior sidewall
- G. Framed windows
- H. Aluminum sidewall structure with 16" on-center framing

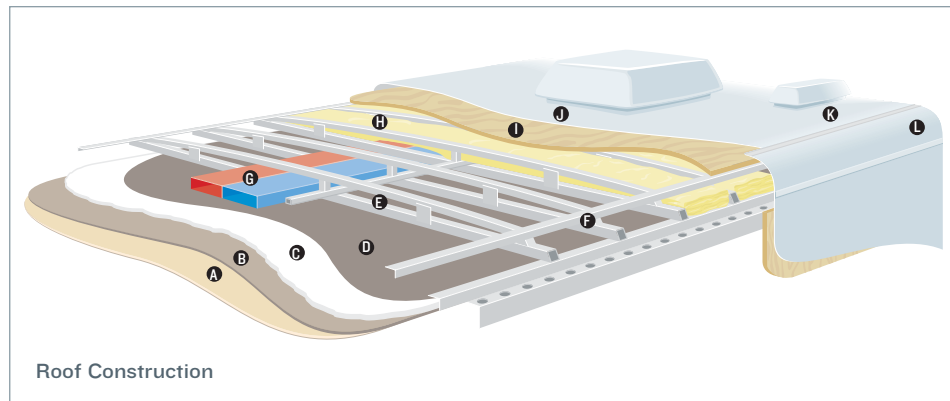

Roof Construction

- A. Padded vinyl overlay
- B. 3/16" panel
- C. 5/8" bead foam
- D. Kraft paper vapor barrier
- E. 1" tubular aluminum truss rafter with full joint weld
- F. Welded aluminum crowned roof structure with 16" on-center framing
- G. True Central Air Conditioning—insulated ducted distribution and return
- H. Fiberglass batten insulation
- I. 7mm wood decking
- J. Brite-Tek or fiberglass roof
- K. One-piece fiberglass caps
- L. Aluminum or fiberglass wrap—additional aluminum reinforced extrusion connecting sidewall to roof for most slideouts

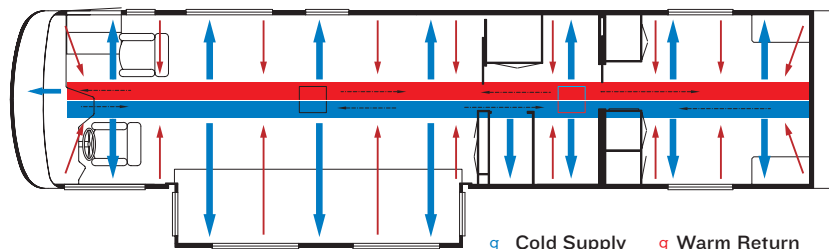

TRUE CENTRAL AIR: Newmar's True Central Air System—standard with every Newmar RV—is just like those found in most site-built homes. It's actually two separate, fully ducted systems: one to distribute incoming cool air, the other to quickly and effectively remove warm air from every living area.





A



B



C



D



E

EXTERIOR FEATURES

- A. Large, powered sideview mirrors
- B. Two new options for 2004: broadband Internet access and a low-profile satellite TV antenna
- C. Accommodating storage compartments with hydraulic piston-supported doors
- D. Now standard on Class A: more powerful Generac® 7.5 kW generator with auto-changeover
- E. Attractive fiberglass end caps

Took a scenic drive through the White Mountains, following the course of the Androscoggin River. Gorgeous—definitely the time of year for this trip!



A



B



C



D

INTERIOR COLORS

- A. Royal Blue
- B. Raw Silk

- C. Antelope
- D. Verde

NEWMARCORP.COM

Here you'll discover the latest model specifications, floor plans and options, as well as information on who we are, how we work and what we believe in.

Real woods will have variations in grain and color. Natural wood products will darken over time.



A



B



C



D



E



F



G



H

EXTERIOR COLORS

(ALL UNITS ARE FULL-PAINT)

- A. Chestnut (Class A)
- B. Steel Blue (Class A)
- C. Topaz (Class A)
- D. Rainforest (Class A)

- E. Raw Silk (Diesel Pusher)
- F. Royal Blue (Diesel Pusher)
- G. Antelope (Diesel Pusher)
- H. Verde (Diesel Pusher)

FULL-PAINT MASTERPIECE FINISH™

The Full-Paint Masterpiece Finish from Newmar creates an exterior of stunning beauty and incredible endurance — a true work of art. Newmar is an industry leader in applying full body paint to its coaches. We are pleased to offer it as an option on your Mountain Aire Class A or Diesel Pusher.



A NEW BREED™

www.workhorse.com



THE LEADER AT EVERY TURN™

www.freightlinerchassis.com



www.spartanmotors.com

THE NEWMAR KOUNTRY KLUB

As a Newmar owner, you qualify for membership in the Newmar Kountry Klub. Join your local chapter, and just look at the perks you'll enjoy: friendship, fun and adventure with other Newmar owners • rallies and caravans • special RV show events • discounts on RV services • a free monthly Klub magazine • Klub merchandise. And that's just for starters.

Join today! Call 877-639-5582, toll-free, or visit the Klub section of *newmarcorp.com*.

THE NEWMAR FACTORY TOUR

We'd love to have you visit our state-of-the-art production facility in Nappanee, Indiana. For details, including tour days and times, please call 574-773-7791.

Wonder where our next road will lead?

NEWMAR CORPORATION
355 N DELAWARE ST
PO BOX 30
NAPPANEE IN 46550-0030
574-773-7791 Fax 574-773-2895
www.newmarcorp.com

Official Newmar Dealer:



NEWMAR QUALITY: A WAY OF LIFE

Some features shown in our literature are optional. Colors and finishes are photographic representations: The actual materials may look different. Prices, specifications and floor plans are subject to change at Newmar's discretion without prior written notice or obligation. Please see your dealer for actual samples and specifications. © 2003 Newmar Corporation. Printed in the U.S.A. (05/03)

2004 MOUNTAIN AIRE

CLASS A / DIESEL PUSHER BY NEWMAR



2004 MOUNTAIN AIRE

CLASS A / DIESEL PUSHER BY NEWMAR

DESTINATION:

New England, Early Fall



NEWMARCORP.COM

SPECIFICATIONS

CLASS A STANDARD FEATURES

MOTORIZED CHASSIS FEATURES

- Cruise Control
- Stainless Steel Wheel Simulators
- Tilt Steering Wheel
- Workhorse® W-22 Chassis

AIR CONDITIONING & HEATING

- Two 13,500-Btu Penguin® Central Air Conditioners
- LP Leak Detector
- Dash Heater and High Output Air Conditioner
- LP Furnace with In-Floor Ducted Heat

APPLIANCES & ACCESSORIES

- Ten-Gal. Gas/Electric Water Heater with Direct Spark Ignition
- Spacesaver Microwave
- Flat Screen Color TV in Living Area
- Flat Screen Color TV in Bedroom
- Three-Burner Recessed Range with Glass Oven Door and Electronic Ignition
- AM/FM Dash Radio with Compact Disc Player
- Dometic® 3862 Refrigerator (8 Cu. Ft.)
- Rearview Color Monitor System
- TV Antenna with Power Booster, One Exterior Jack and Two Interior Jacks
- VCR and TV Video Selector Switch
- Cable TV Connection with RG 6 Coax
- Satellite Prep (Phone, TV Jack and Recept)
- Trumpet Horn
- Speaker Switch System
- TV Antenna Warning Light on Dash

CABINETS & FURNITURE

- Flexsteel® Leather/Vinyl Front Seats with Six-Way Power, Ergo Flex Arms and Power Lumbar
- Flexsteel Swivel Rocker Recliner
- Flexsteel Sofa With a Drawer
- Drawers with Metal Guides
- Hidden-Leaf Dinette Table with Two Fixed Chairs and Two Folding Chairs
- Oak Hardwood Cabinets with Raised Panel Double-Arched Doors
- Corian® Countertop in Kitchen with Undermount Acrylic Sink and Flush Sink Covers
- Corian® Countertop in Bathroom with Porcelain Bowl
- Lifts on Bed Top to Access Storage Area

ELECTRICAL FEATURES

- 75-amp Converter
- Battery Disconnect for House Batteries
- 7,500-watt Guardian® Generator with Remote Switch and Automatic Changeover
- 5-watt Solar Panel to Charge Chassis Battery
- 50-amp Electrical Service with Flexible Cord
- Emergency Engine Start Switch
- Exterior Security Lights, One Installed on Each Side
- Lights in Exterior Storage Compartments
- Daytime Headlight System
- Lights in Wardrobes
- Solar Prep, 10-gauge Wire from Roof to Battery Compartment
- ICC Light Flasher Switch
- Driving Lights
- Interior Courtesy Lights
- Midship Side Turn Signals

EXTERIOR FEATURES

- BriteTek® Roof with 7mm Decking
- Convex Exterior Mirrors with Remote Control and Defrost
- Gel-Coated Fiberglass Exterior Sides
- Class 3, 5,000 lb. Hitch
- Hydraulic Leveling Jacks with Touch Manual Control
- Fully Painted Exterior Graphics with Clearcoat Finish
- Front Protective Film

INTERIOR FEATURES

- Lined Day/Night Pleated Window Shades and Lambrequins
- Padded Vinyl Ceiling
- Simulated Ceramic-Look Floor in Kitchen and Bath Areas
- Quilted Bedspread with Reverse Sham, Matching Bed Base and Accent Pillow
- Sun Shade on Driver and Passenger Side Windows
- Hardwood Fascia on Living Area Slideout

PLUMBING & BATH FEATURES

- Exterior Shower, Located on Off-Door Side
- Monitor Panel
- Sewage Holding-Tank Rinse
- SeaLand® 500+ China Stool
- Fiberglass Tub/Shower with Glass Shower Door
- Water-Heater Bypass System
- Demand Water System with Aquajet® ES Pump

CONSTRUCTION FEATURES

- Aluminum-Frame Sidewalls and Roof Construction, 16" On Center
- Roof R-Value Rating: I6
- Sidewall R-Value Rating: II
- Floor R-Value Rating: II
- 5/8" Foam Insulation Laminated in Sidewalls and Ceiling
- R7 Fiberglass Insulation in Sidewalls and Floor, R11 in Roof

WINDOWS, AWNINGS & VENTS

- Double-Pane Tinted Safety Glass Windows
- Automatic Double Entrance-Door Step
- Power Vent in Bathroom with Wall Switch
- Fan-Tastic® Vent with Rain Sensor in Kitchen Area
- Skylight in Bathroom
- A&E® 9000 Side Awning

CLASS A OPTIONAL FEATURES

MOTORIZED CHASSIS FEATURES

- Polished Aluminum Wheels

APPLIANCES & ACCESSORIES

- 30" Convection Microwave with Three-Burner Cooktop (13 lb.)
- Norcold® Four-Door Refrigerator (45 lb.)
- Dometic® 1062 Refrigerator, 10 Cu. Ft., (91 lb.)
- Dometic 1292 Refrigerator, 12 Cu. Ft., (47 lb.)
- U-Line IceMaker (57 lb.)
- CB Radio (2 lb.)
- Washer/Dryer Prep
- Compact Washer/Dryer (185 lb.)
- Two-Piece Washer/Dryer (232 lb.)
- External Entertainment Center (40 lb.)
- XM Satellite Radio Capability (2 lb.)

CABINETS & FURNITURE

- Coastal Cherry Hardwood Cabinets
- Summer Maple Hardwood Cabinets
- Washington Cherry Hardwood Cabinets (25 lb.)
- Built-In Booth Dinette (23 lb.)
- Combination Desk/Dinette Table (50 lb.)
- Undermount Solid-Surface Sinks in Kitchen and Bathroom (25 lb.)

SPECIFICATIONS

CLASS A OPTIONAL FEATURES, continued

ELECTRICAL FEATURES

- 400-watt Inverter for Dash TV (10 lb.)
- Roof-Mounted Spotlight (3 lb.)
- 7,000 Onan® Generator (42 lb.)
- Recessed Docking Lights (4 lb.)
- Exterior Security Lights, Two Installed on Each Side

EXTERIOR FEATURES

- Convex Exterior Chrome Mirrors with Remote Control and Defrost
- Gel-Coated Fiberglass Roof and Top Wrap (96 lb.)
- Rear Ladder (4 lb.)

INTERIOR FEATURES

- Ceramic Floor Tile in Bath Area (75 lb.)
- Simulated Plank Floor in Kitchen and Bath Areas
- Power-Activated Sun Visors

WINDOWS, AWNINGS & VENTS

- Driver's-Side Door with Power Window (50 lb.)
- Fan-Tastic® Vent in Bathroom (11 lb.)

DIESEL PUSHER STANDARD FEATURES

MOTORIZED CHASSIS FEATURES

- Cruise Control
- Anti-Lock Braking System
- Tilt and Telescope Steering Wheel
- Polished Aluminum Wheels
- Recessed Fuel Fills with Crossover To Fill From Either Side
- Freightliner® Chassis, Standard on 40' Floor Plans
- Spartan® Chassis with Tag Axle, Standard on 41' and 43' Floor Plans
- Back-Up Alarm

AIR CONDITIONING & HEATING

- Two 15,000-Btu Penguin® Heat Pump Central Air Conditioners
- LP Leak Detector
- Dash Heater and High-Output Air Conditioner

APPLIANCES & ACCESSORIES

- Ten-Gal. Gas/Electric Water Heater with Direct-Spark Ignition
- 30" Convection Microwave
- Flat-Screen Color TV in Living Area
- Flat-Screen Color TV in Bedroom
- Three-Burner Recessed Cooktop with Electronic Ignition
- AM/FM/XM Satellite Radio and Color Monitor with Remote Six-Disc CD Player and Combination Rearview Color Monitor System
- Dometic® I062 Refrigerator with Icemaker (10 Cu. Ft.)
- TV Antenna with Power Booster, One Exterior Jack and Two Interior Jacks
- VCR and TV Video Selector Switch
- Cable TV Connection with RG 6 Coax
- Satellite Prep, Phone, TV Jack and Recept
- Washer/Dryer Prep for Compact Washer/Dryer
- Air Horns
- Safe
- Speaker Switch System
- TV Antenna Warning Light on Dash

CABINETS & FURNITURE

- Flexsteel® Leather/Vinyl Heated Front Seats with Eight-Way Power, Power Lumbar
- Flexsteel Distressed Leather/Vinyl Push-Back Recliner with Ottoman
- Flexsteel Sofa with a Drawer
- Drawers with Metal Guides
- Dinette Table with Corian® Insert Top and Four Chairs
- Oak Hardwood Cabinets with Raised Panel Double-Arched Doors
- Corian® Countertop in Kitchen with Integrated Sink Bowls and Flush Sink Covers
- Luxurious Pillowtop Mattress
- Undermount Solid Surface Sinks

ELECTRICAL FEATURES

- 75-amp Converter
- Battery Disconnect for House Batteries
- 8.0 PowerTech® Diesel Quiet Series Generator on Slides with Automatic Changeover
- 5-watt Solar Panel to Charge Chassis Battery
- 50-amp Electrical Service with Flexible Cord
- Emergency Engine Start Switch
- Exterior Security Lights, One Installed on Each Side
- Lights in Exterior Storage Compartments
- Daytime Headlight System
- Lights in Wardrobes
- Solar Prep, Wire from Roof to Battery Compartment
- ICC Light Flasher Switch
- Four 6 V House Batteries on Pullout Tray
- Recessed Docking Lights
- Driving Lights
- Interior Courtesy Lights
- Midship Side Turn Signals
- Mood Lights Recessed in Ceiling

EXTERIOR FEATURES

- Convex Exterior Chrome Mirrors with Remote Control, Defrost and Turn-Signal Indicators
- Gel-Coated Fiberglass Exterior Sides
- Class 5, 10,000 lb. Hitch
- Four-Point Hydraulic Leveling Jacks with Automatic Control and Air Dump
- Fully Painted Exterior Graphics with Clearcoat Finish
- Front Protective Film
- One-Piece Molded-Fiberglass Roof/Wrap

INTERIOR FEATURES

- Lined Day/Night Pleated Window Shades and Lambrequins
- Padded Vinyl Ceiling
- Quilted Bedspread with Reverse Sham, Matching Bed Base, and Accent Pillow
- Simulated Plank Floor in Kitchen and Bath Areas
- Sun Shade on Driver and Passenger Side Windows
- Hardwood Fascia on Living Area Slideout
- Power Activated Sun Visors
- Sculptured Carpeting in Living Area

SPECIFICATIONS

DIESEL PUSHER STANDARD FEATURES, continued

PLUMBING & BATH FEATURES

- Exterior Convenience Wash Station with Hot/Cold Water, Soap Dispenser and Towel Dispenser
- Monitor Panel
- Sewage Holding-Tank Rinse
- Thetford® Aria Sculptured China Stool
- Fiberglass Tub/Shower with Glass Shower Door
- Water-Heater Bypass System
- Demand Water System with Aquajet® ES Pump
- Automatic-Rewind Water-Hose Reel
- Water Filter with Drink Dispenser at Kitchen Sink

CONSTRUCTION FEATURES

- Aluminum-Frame Sidewalls and Roof Construction, 16" On Center
- Roof R-Value Rating: I6
- Sidewall R-Value Rating: II
- Floor R-Value Rating: I2
- 5/8" Foam Insulation Laminated in Sidewalls and Ceiling
- R7 Fiberglass Insulation in Sidewalls and Floor, R11 in Roof

WINDOWS, AWNINGS & VENTS

- Double-Pane Tinted Safety-Glass Windows
- Automatic Double-Entrance Door Step
- Fan-Tastic® Vent with Rain Sensor in Kitchen and Bathroom
- Skylight in Bathroom
- A&E® 9000 Side Awning
- Front Entry Door with Power Flush Stepwell Cover
- Driver's-Side Power Window
- A&E® Slideout Covers

DIESEL PUSHER OPTIONAL FEATURES

MOTORIZED CHASSIS FEATURES

- Spartan® 400-HP Mountain Master Chassis Available on 40' Floorplans
- Trip Tek Electronic Travel Information (5 lb.)

AIR CONDITIONING & HEATING

- Hydronic Zone Heating System (225 lb.)

APPLIANCES & ACCESSORIES

- Norcold® Four-Door Refrigerator with Icemaker (45 lb.)
- Dometic® I292 Refrigerator with Icemaker, 12 Cu. Ft. (47 lb.)
- Compact Washer/Dryer (185 lb.)
- Navigation System Displayed on Rearview Monitor Screen (8 lb.)
- U-Line Icemaker (57 lb.)
- Bose® 3-2-1 System, DVD/CD Player and Subwoofer (15 lb.)
- External Entertainment Center with Flat-Screen TV and AM/FM CD Radio (132 lb.)
- Plasma Color TV in Living Area
- 100 lb. Norcold Freezer on Pullout Tray (113 lb.)
- CB Radio (2 lb.)
- Dishwasher (75 lb.)
- OnStar® System with First-Year \$400 Service Included
- Two-Piece Washer/Dryer

CABINETS & FURNITURE

- Coastal Cherry Hardwood Cabinets
- Washington Cherry Hardwood Cabinets
- Summer Maple Hardwood Cabinets
- Built-In Booth Dinette (23 lb.)
- Combination Desk/Dinette Table (50 lb.)
- Folding Coffee Table (20 lb.)
- King-Size Bed
- Oversized Passenger Seat with Power Footrest (68 lb.)

ELECTRICAL FEATURES

- Trace® 2,000-watt Inverter (50 lb.)
- Roof-Mounted Spotlight (3 lb.)
- Automatic Generator Start
- 7.5 Onan® Diesel Quiet Series Generator (25 lb.)
- Exterior Security Lights, Two on Each Side (2 lb.)
- Power-Rewind Cord Reel (50 lb.)

EXTERIOR FEATURES

- Rear Ladder (4 lb.)

INTERIOR FEATURES

- Ceramic Floor Tile in Kitchen and Bath Areas (110 lb.)
- Ceramic Floor Tile in Between Driver and Passenger Seats (80 lb.)
- Front-Entry Floor Mat (8 lb.)
- Hardwood Lambrequin Window Treatment in Living Area (30 lb.)
- Power-Activated Sun Shades on Driver and Passenger Side Windows (3 lb.)

WINDOWS, AWNINGS & VENTS

- Keyless Entrance Door Pad

CLASS A FLOOR PLANS

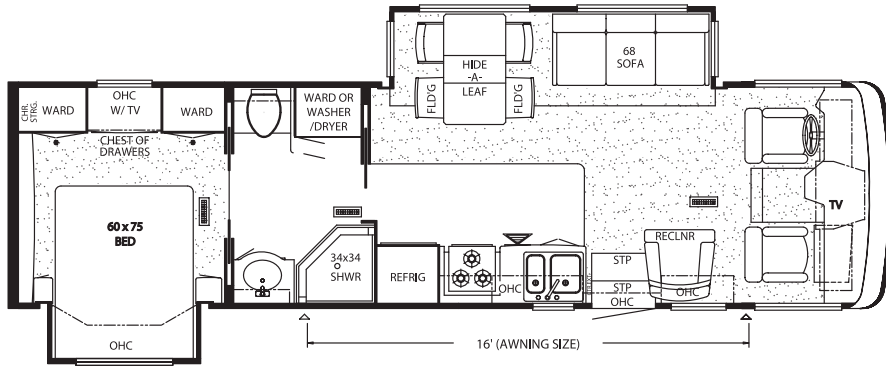

Model Shown: MACA 3357

Options: K122, K420

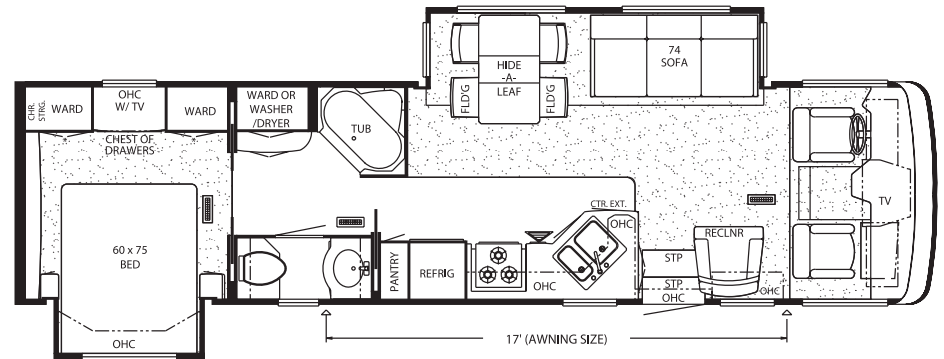

Model Shown: MACA 3501

Options: K122, K420

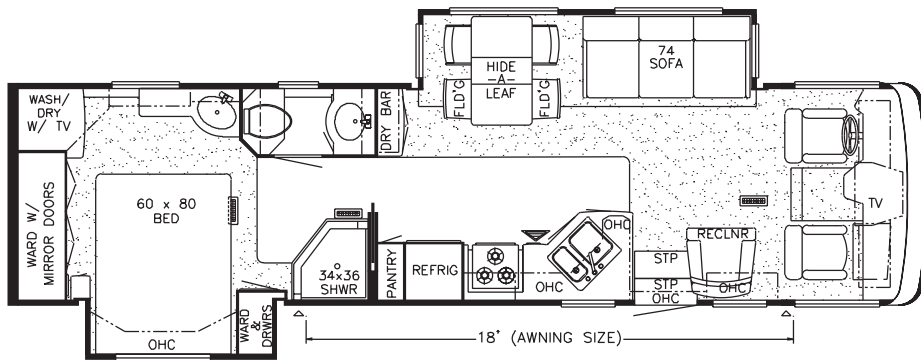

Model Shown: MACA 3504

Options: K122, K420, K822

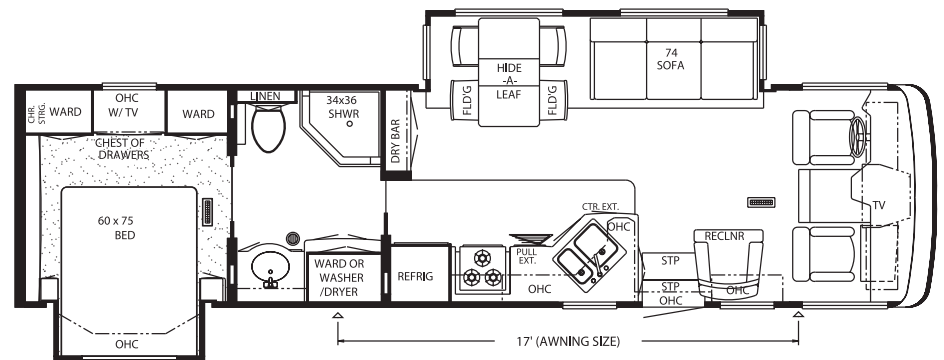

Model Shown: MACA 3560

Options: K122, K420

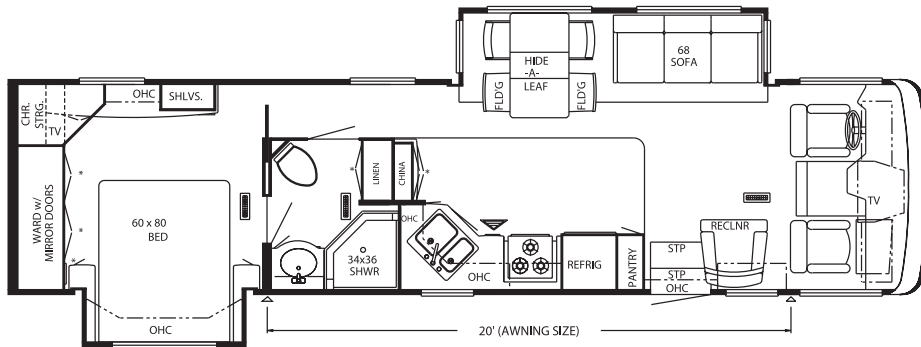

Model Shown: MACA 3651

Options: J780-2, K122, K420

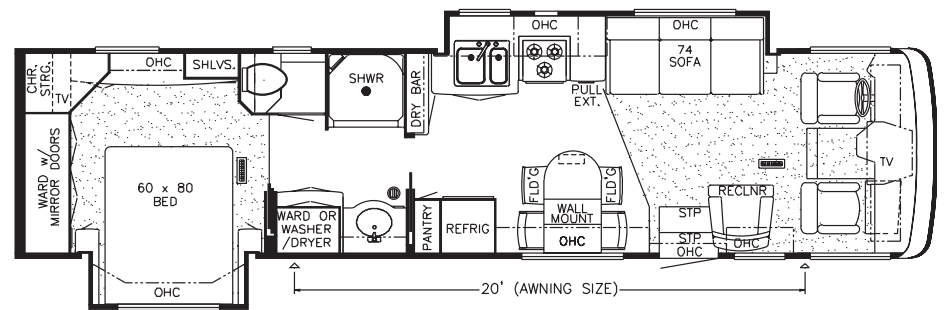

Model Shown: MACA 3707

Options: K122-4, K421

CLASS A AND DIESEL PUSHER FLOOR PLANS

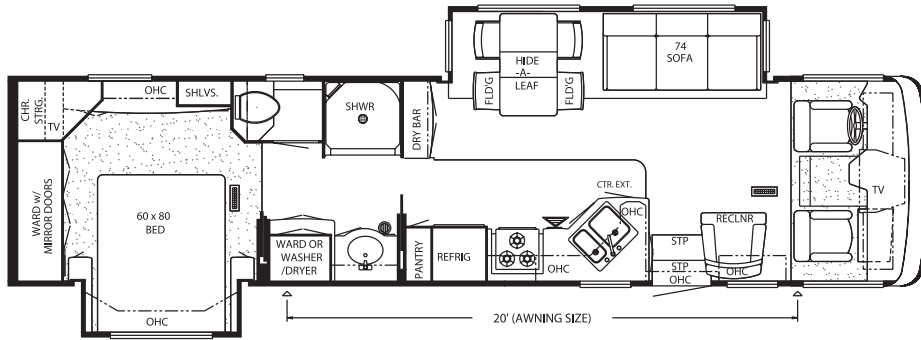

Model Shown: MACA 3778

Options: K122, K420

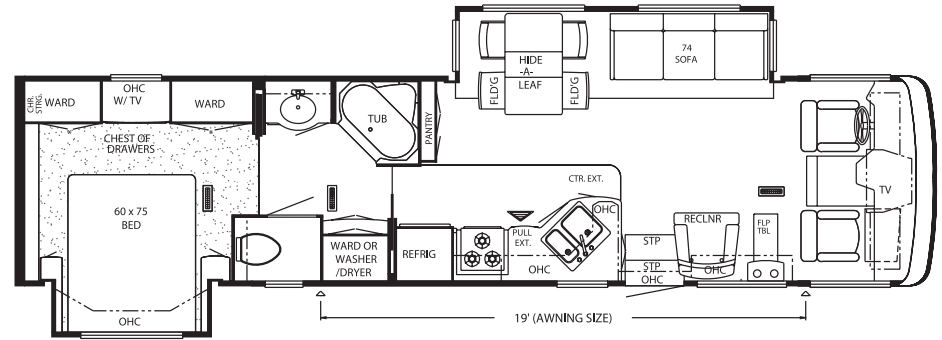

Model Shown: MACA 3781

Options: K122, K420

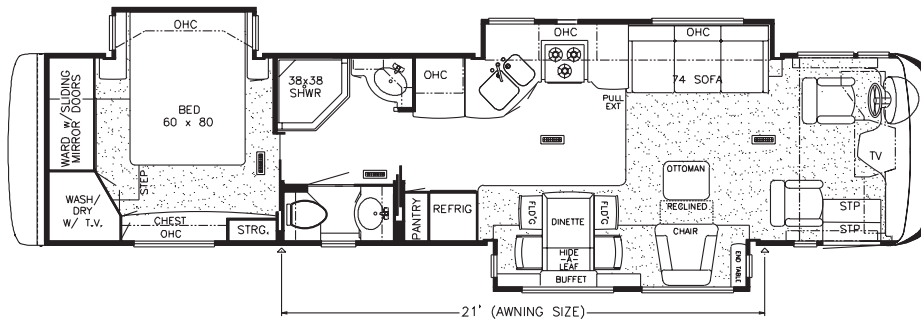

Model Shown: MADP 4016

Options: K122-2, K421-2, K422

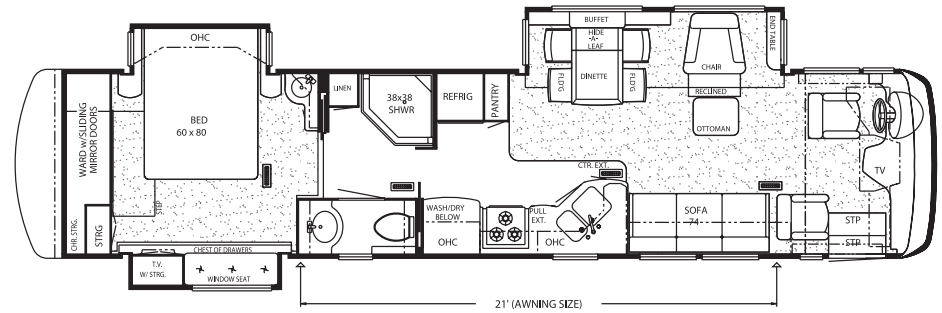

Model Shown: MADP 4017

Options: K122, K235, K330, K420, K422, K915

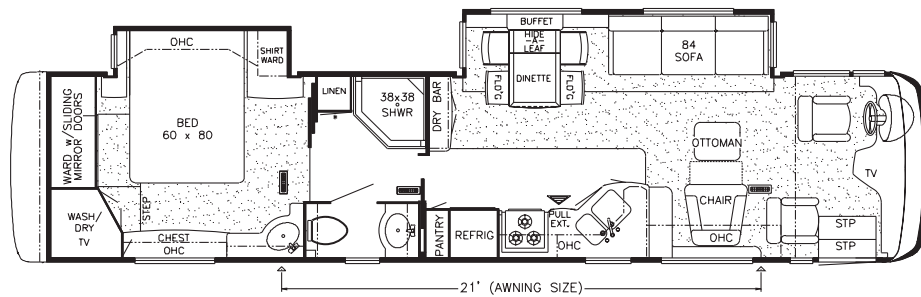

Model Shown: MADP 4018

Options: K122, K140, K280-4, K326, K420, K422, K630, K800

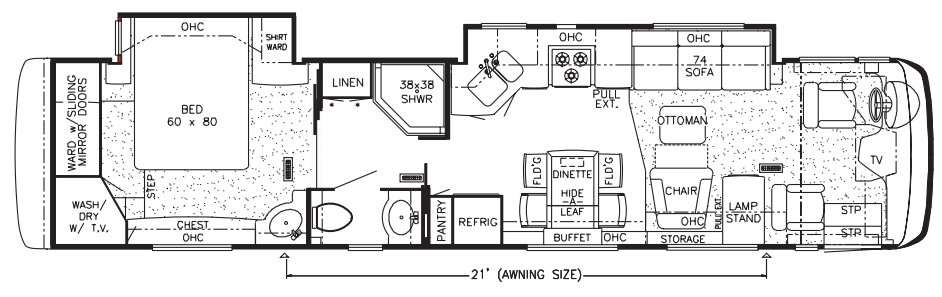

Model Shown: MADP 4019

Options: K122-4, K280-9, K421, K630-3, K910, P370

DIESEL PUSHER FLOOR PLANS

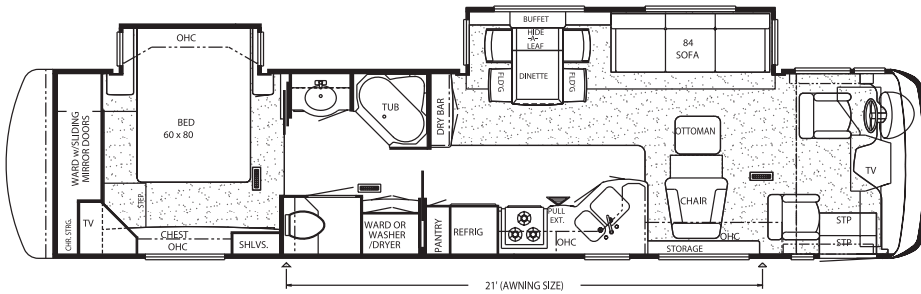

Model Shown: MADP 4020

Options: K122, K140, K326, K420, K422, K641, K800

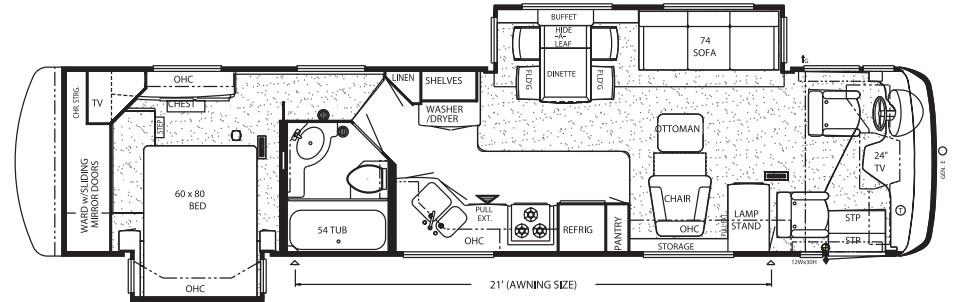

Model Shown: MADP 4021

Options: K122, K211, K235, K420, K422, K641, K915

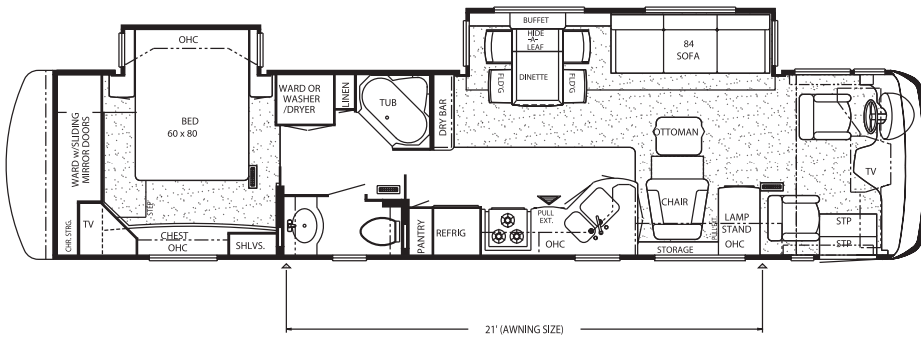

Model Shown: MADP 4022

Options: K122, K235, K420, K800, P260

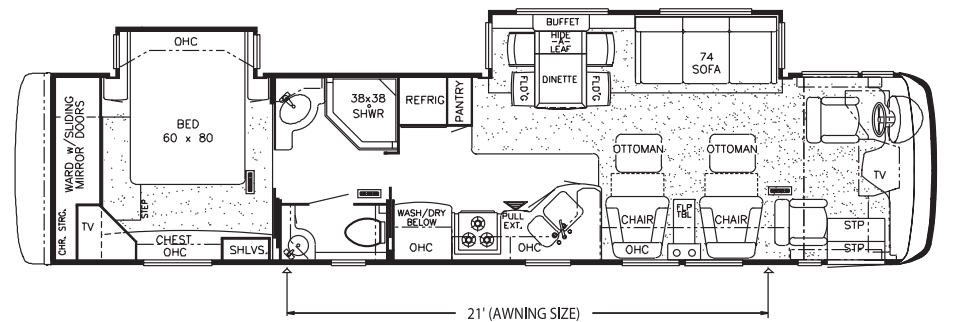

Model Shown: MADP 4101

Options: K122, K235, K420, K422, K641, K641-I, K915

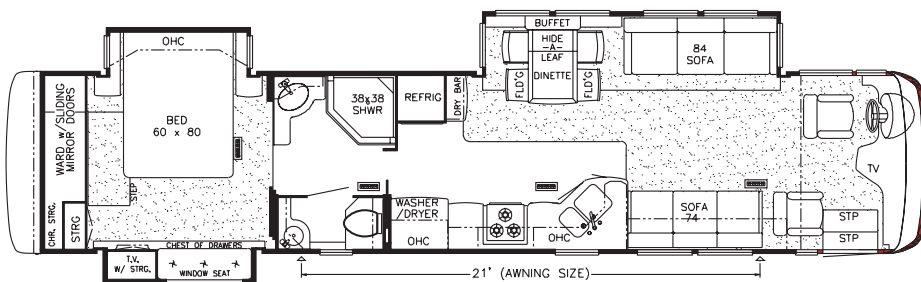

Model Shown: MADP 4301

Options: K122, K235, K330, K420, K422, K630-2, K915

FLOOR PLAN OPTIONS

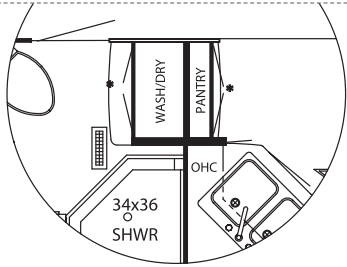

J780-2: WASHER/DRYER PREP
MACA: 3651

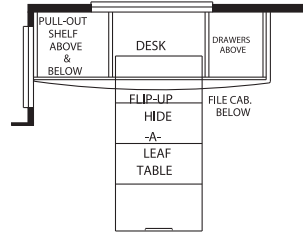

K122: DINETTE-COMPUTER STATION COMBO
MACA: 3357, 3501, 3504, 3560, 3651, 3778, 3781

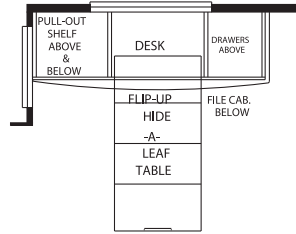

K122: DINETTE-COMPUTER STATION COMBO
MADP: 4017, 4018, 4020, 4021, 4022, 4101, 4301

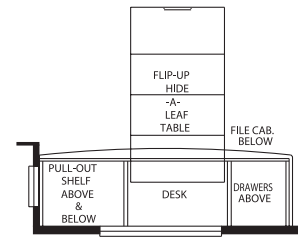

K122-2: DINETTE-COMPUTER STATION COMBO
MADP: 4016

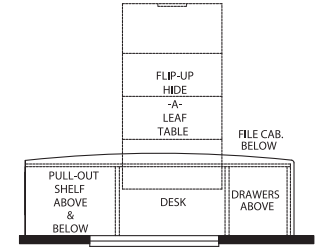

K122-4: DINETTE-COMPUTER STATION COMBO
MACA: 3707 MADP: 4019

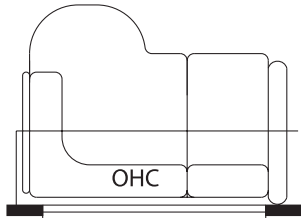

K140: 58" LEATHER L-SOFA
MADP: 4018, 4020

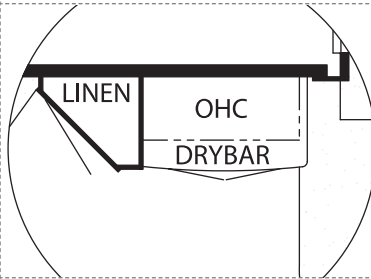

K211: DRY BAR
MADP: 4021

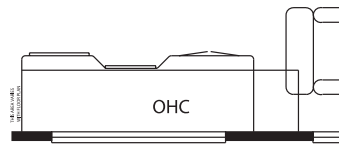

K235: 61" DESK
MADP: 4017, 4021, 4022, 4101, 4301

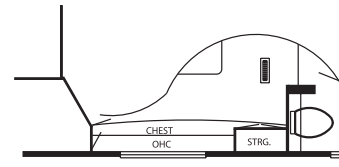

K280-4: STORAGE
MADP: 4018

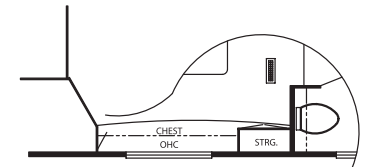

K280-9: STORAGE
MADP: 4019

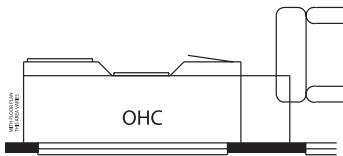

K326: 53" DESK
MADP: 4018, 4020

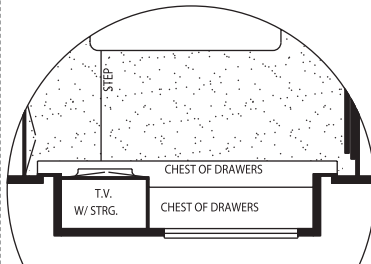

K330: DRESSER SLIDEOUT CHEST
MADP: 4017, 4301

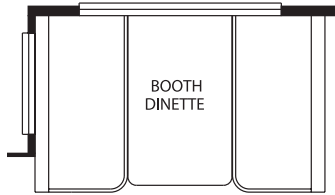

K420: BOOTH DINETTE
MACA: 3357, 3501, 3504, 3560, 3651, 3778, 3781

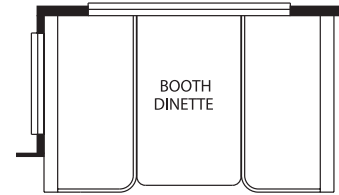

K420: BOOTH DINETTE
MADP: 4017, 4018, 4020, 4021, 4022, 4101, 4301

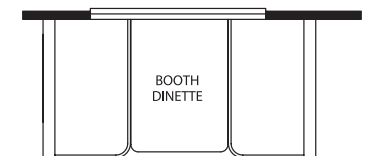

K421: BOOTH DINETTE WITH DRAWERS
MACA: 3707 MADP: 4019

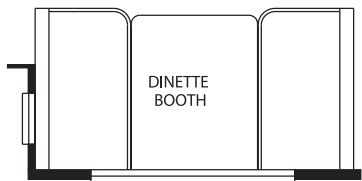

K421-2: BOOTH DINETTE WITH DRAWERS
MADP: 4016

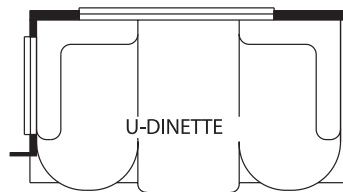

K422: U-DINETTE
MADP: 4016, 4017, 4018, 4020, 4021, 4101, 4301

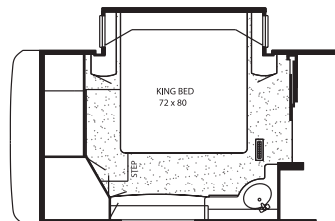

K630: KING BED
MADP: 4018

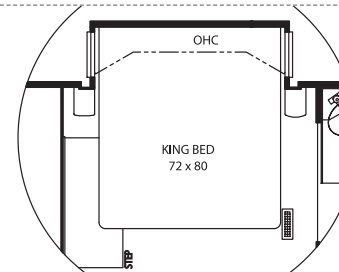

K630-2: KING BED
MADP: 4301

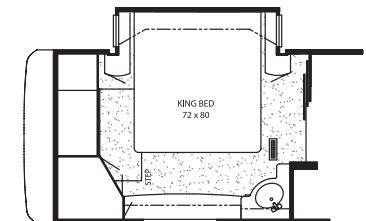

K630-3: KING BED
MADP: 4019

FLOOR PLAN OPTIONS

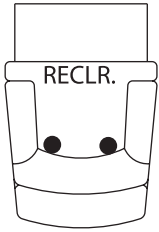

K64I: RECLINERS MADP: 4016, 4017, 4018, 4019, 4020, 4021, 4022, 4101

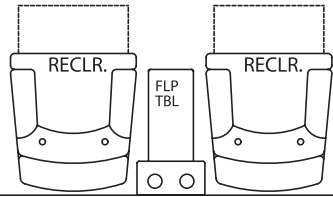

K64I-I: RECLINERS MADP: 4101

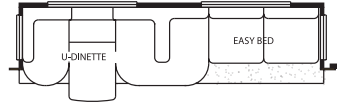

K800: U-DINETTE & L-SOFA MADP: 4018, 4020, 4022

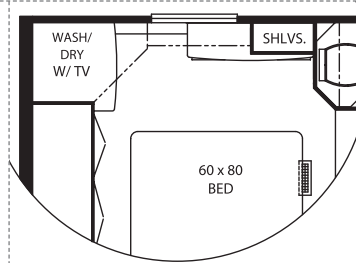

K822: DRESSER CENTER W/ STORAGE TOWER MACA: 3504

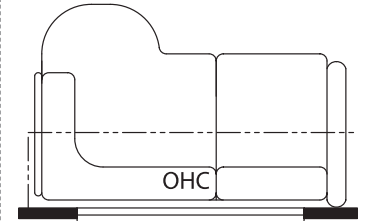

K910: 66" L-SOFA MADP: 4019

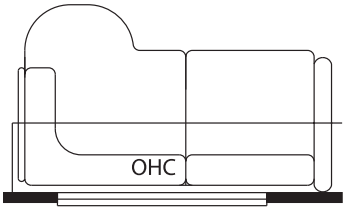

K915: 72" L-SOFA WITH INCLINER MADP: 4017, 4021, 4101, 4301

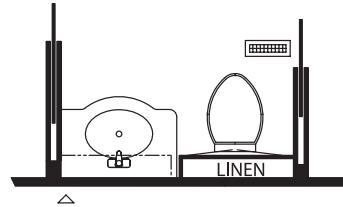

P260: NON-ENCLOSED BATHROOM MADP: 4022

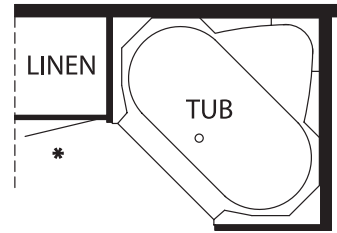

P370: CORNER TUB MADP: 4019

CLASS A FLOOR PLAN SPECIFICATIONS

FLOOR PLAN	APP. OVERALL LENGTH	WIDTH	APP. OVERALL HEIGHT	INTERIOR WIDTH	INTERIOR HEIGHT	GREY	SEWAGE	WATER	LP	FURNACE	WATER HEATER
MACA 3357	33' 5"	100"	12'	94"	78"	50 gal.	50 gal.	75 gal.	25 gal.	35,000 btu	10 gal.
MACA 3501	35' 5"	100"	12'	94"	78"	50 gal.	50 gal.	75 gal.	25 gal.	35,000 btu	10 gal.
MACA 3504	35' 5"	100"	12'	94"	78"	50 gal.	50 gal.	75 gal.	25 gal.	35,000 btu	10 gal.
MACA 3560	35' 5"	100"	12'	94"	78"	50 gal.	50 gal.	75 gal.	25 gal.	35,000 btu	10 gal.
MACA 3651	36' 9"	100"	12'	94"	78"	50 gal.	50 gal.	75 gal.	25 gal.	42,000 btu	10 gal.
MACA 3707	37' 7"	100"	12'	94"	78"	50 gal.	50 gal.	75 gal.	25 gal.	42,000 btu	10 gal.
MACA 3778	37' 7"	100"	12'	94"	78"	50 gal.	50 gal.	75 gal.	25 gal.	42,000 btu	10 gal.
MACA 3781	37' 7"	100"	12'	94"	78"	50 gal.	50 gal.	75 gal.	25 gal.	42,000 btu	10 gal.

DIESEL PUSHER FLOOR PLAN SPECIFICATIONS

FLOOR PLAN	APP. OVERALL LENGTH	WIDTH	APP. OVERALL HEIGHT	INTERIOR WIDTH	INTERIOR HEIGHT	GREY	SEWAGE	WATER	LP	FURNACE	WATER HEATER
MADP 4016	40' 06"	101.5"	12' 3"	95.5"	80"	65 gal.	45 gal.	105 gal.	32 gal.	42,000 btu	10 gal.
MADP 4017	40' 06"	101.5"	12' 3"	95.5"	80"	65 gal.	45 gal.	105 gal.	32 gal.	42,000 btu	10 gal.
MADP 4018	40' 06"	101.5"	12' 3"	95.5"	80"	65 gal.	45 gal.	105 gal.	32 gal.	42,000 btu	10 gal.
MADP 4019	40' 06"	101.5"	12' 3"	95.5"	80"	65 gal.	45 gal.	105 gal.	32 gal.	42,000 btu	10 gal.
MADP 4020	40' 06"	101.5"	12' 3"	95.5"	80"	65 gal.	45 gal.	105 gal.	32 gal.	42,000 btu	10 gal.
MADP 4021	40' 06"	101.5"	12' 3"	95.5"	80"	65 gal.	45 gal.	105 gal.	32 gal.	42,000 btu	10 gal.
MADP 4022	40' 06"	101.5"	12' 3"	95.5"	80"	65 gal.	45 gal.	105 gal.	32 gal.	42,000 btu	10 gal.
MADP 4101	40' 06"	101.5"	12' 4"	95.5"	80"	65 gal.	45 gal.	105 gal.	32 gal.	42,000 btu	10 gal.
MADP 4301	42' 06"	101.5"	12' 4"	95.5"	80"	65 gal.	45 gal.	105 gal.	32 gal.	42,000 btu	10 gal.

CHASSIS SPECIFICATIONS

WORKHORSE CHASSIS INFORMATION (Class A)

FLOOR PLAN	ENGINE HP	AXLE RATIO	FUEL CAP.	WHEEL BASE	*FRONT GAWR	*REAR GAWR	*GVWR	*GCWR	APP. UVW	APP. NCC
MACA 3357	340	5.38	75 gal.	208"	8,500 lb.	14,500 lb.	22,000 lb.	26,000 lb.	18,145 lb.	3,855 lb.
MACA 3501	340	5.38	75 gal.	228"	8,500 lb.	14,500 lb.	22,000 lb.	26,000 lb.	18,736 lb.	3,264 lb.
MACA 3504	340	5.38	75 gal.	228"	8,500 lb.	14,500 lb.	22,000 lb.	26,000 lb.	18,666 lb.	3,334 lb.
MACA 3560	340	5.38	75 gal.	228"	8,500 lb.	14,500 lb.	22,000 lb.	26,000 lb.	18,465 lb.	3,525 lb.
MACA 3651	340	5.38	75 gal.	242"	8,500 lb.	14,500 lb.	22,000 lb.	26,000 lb.	19,056 lb.	2,944 lb.
MACA 3707	340	5.38	75 gal.	242"	8,500 lb.	14,500 lb.	22,000 lb.	26,000 lb.	19,130 lb.	2,870 lb.
MACA 3778	340	5.38	75 gal.	242"	8,500 lb.	14,500 lb.	22,000 lb.	26,000 lb.	19,204 lb.	2,796 lb.
MACA 3781	340	5.38	75 gal.	242"	8,500 lb.	14,500 lb.	22,000 lb.	26,000 lb.	19,059 lb.	2,941 lb.

FREIGHTLINER CHASSIS INFORMATION (Diesel Pusher—Standard)

FLOOR PLAN	ENGINE HP	AXLE RATIO	FUEL CAP.	WHEEL BASE	*FRONT GAWR	*REAR GAWR	*GVWR	*GCWR	APP. UVW	APP. NCC
MADP 4016	400	4.63	150 gal.	276"	14,000 lb.	20,000 lb.	34,000 lb.	44,000 lb.	27,657 lb.	6,343 lb.
MADP 4017	400	4.63	150 gal.	276"	14,000 lb.	20,000 lb.	34,000 lb.	44,000 lb.	27,016 lb.	6,984 lb.
MADP 4018	400	4.63	150 gal.	276"	14,000 lb.	20,000 lb.	34,000 lb.	44,000 lb.	26,855 lb.	7,145 lb.
MADP 4019	400	4.63	150 gal.	276"	14,000 lb.	20,000 lb.	34,000 lb.	44,000 lb.	27,102 lb.	6,898 lb.
MADP 4020	400	4.63	150 gal.	276"	14,000 lb.	20,000 lb.	34,000 lb.	44,000 lb.	26,906 lb.	7,094 lb.
MADP 4021	400	4.63	150 gal.	276"	14,000 lb.	20,000 lb.	34,000 lb.	44,000 lb.	26,439 lb.	7,561 lb.
MADP 4022	400	4.63	150 gal.	276"	14,000 lb.	20,000 lb.	34,000 lb.	44,000 lb.	27,072 lb.	6,928 lb.

SPARTAN CHASSIS INFORMATION (Diesel Pusher—Optional)

FLOOR PLAN	ENGINE HP	AXLE RATIO	FUEL CAP.	WHEEL BASE	*FRONT GAWR	*REAR GAWR	*TAG GAWR	*GVWR	*GCWR	APP. UVW	APP. NCC
MADP 4016	400	4.88	150 gal.	276"	14,200 lb.	20,000 lb.		34,200 lb.	44,200 lb.	27,737 lb.	6,463 lb.
MADP 4017	400	4.88	150 gal.	276"	14,200 lb.	20,000 lb.		34,200 lb.	44,200 lb.	27,463 lb.	6,737 lb.
MADP 4018	400	4.88	150 gal.	276"	14,200 lb.	20,000 lb.		34,200 lb.	44,200 lb.	26,934 lb.	7,266 lb.
MADP 4019	400	4.88	150 gal.	276"	14,200 lb.	20,000 lb.		34,200 lb.	44,200 lb.	27,121 lb.	7,079 lb.
MADP 4020	400	4.88	150 gal.	276"	14,200 lb.	20,000 lb.		34,200 lb.	44,200 lb.	27,168 lb.	7,032 lb.
MADP 4021	400	4.88	150 gal.	276"	14,200 lb.	20,000 lb.		34,200 lb.	44,200 lb.	26,859 lb.	7,341 lb.
MADP 4022	400	4.88	150 gal.	276"	14,200 lb.	20,000 lb.		34,200 lb.	44,200 lb.	27,298 lb.	6,902 lb.
MADP 4101	400	4.88	150 gal.	252" + Tag	14,200 lb.	20,000 lb.	10,000 lb.	44,200 lb.	54,200 lb.	29,049 lb.	15,153 lb.
MADP 4301	400	4.88	150 gal.	276" + Tag	14,200 lb.	20,000 lb.	10,000 lb.	44,200 lb.	54,200 lb.	30,500 lb.	13,700 lb.

Lengths, Heights, Widths and Dry Weights are approximate. Weight will vary based on optional equipment added to the above base weight.

GAWR: Gross Axle Weight Rating is the maximum permissible weight for an axle.

GVWR: Gross Vehicle Weight Rating is the maximum permissible weight of a fully loaded motorhome.

GCWR: Gross Combination Weight Rating is the value specified by the manufacturer of the vehicle as the maximum allowable loaded weight of this motorhome and any towed trailer or towed vehicle.

UVW: Unloaded Vehicle Weight is the weight of this motorhome as built at the factory with full fuel, engine oil and coolants. The UVW does not include cargo, fresh water, LP gas or dealer-installed accessories.

NCC: Net Carrying Capacity is the maximum weight of all occupants, including the driver, personal belongings, food, fresh water, waste water, LP gas, tools, tongue weight of towed vehicle, dealer-installed accessories, etc., that can be carried by the motorhome.

* Specifications supplied by chassis manufacturer.



A NEW BREED.[™]
www.workhorse.com



THE LEADER AT EVERY TURN[®]
www.freightlinerchassis.com



www.spartanmotors.com

THE NEWMAR KOUNTRY KLUB

As a Newmar owner, you qualify for membership in the Newmar Kountry Klub. Join your local chapter, and just look at the perks you'll enjoy: friendship, fun and adventure with other Newmar owners • rallies and caravans • special RV show events • discounts on RV services • a free monthly Klub magazine • Klub merchandise. And that's just for starters.

Join today! Call 877-639-5582, toll-free, or visit the Klub section of *newmarcorp.com*.

THE NEWMAR FACTORY TOUR

We'd love to have you visit our state-of-the-art production facility in Nappanee, Indiana. For details, including tour days and times, please call 574-773-7791.

Wonder where our next road will lead?

NEWMAR CORPORATION
355 N DELAWARE ST
PO BOX 30
NAPPANEE IN 46550-0030
574-773-7791 Fax 574-773-2895
www.newmarcorp.com

Official Newmar Dealer:



NEWMAR QUALITY: A WAY OF LIFE

Some features shown in our literature are optional. Colors and finishes are photographic representations: The actual materials may look different. Prices, specifications and floor plans are subject to change at Newmar's discretion without prior written notice or obligation. Please see your dealer for actual samples and specifications. © 2003 Newmar Corporation. Printed in the U.S.A. (05/03)