

2007

CLASS C  
MOTORHOMES

# VISTA CRUISER



TM



DEDICATED TO QUALITY,  
INNOVATION AND  
VALUE.

# VISTA CRUISER



TM

# VISTA CRUISER



TM

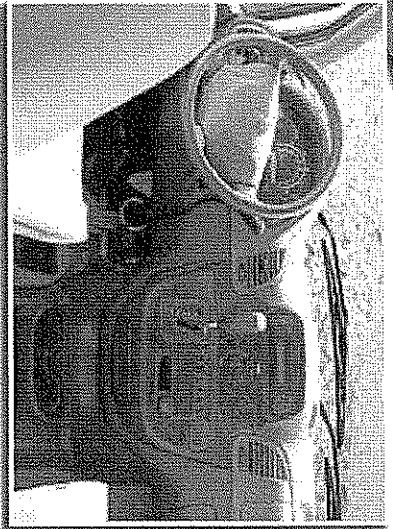

## DRIVE ...

- Truly a joy to drive the Vista Mini is fully equipped.
- Driver / passenger airbag
  - Power steering
  - Easy to read gauges
  - In dash stereo
  - Climate zone control
  - Adjustable seating
  - Top shift,
  - 5-speed transmission
  - Unmatched visibility

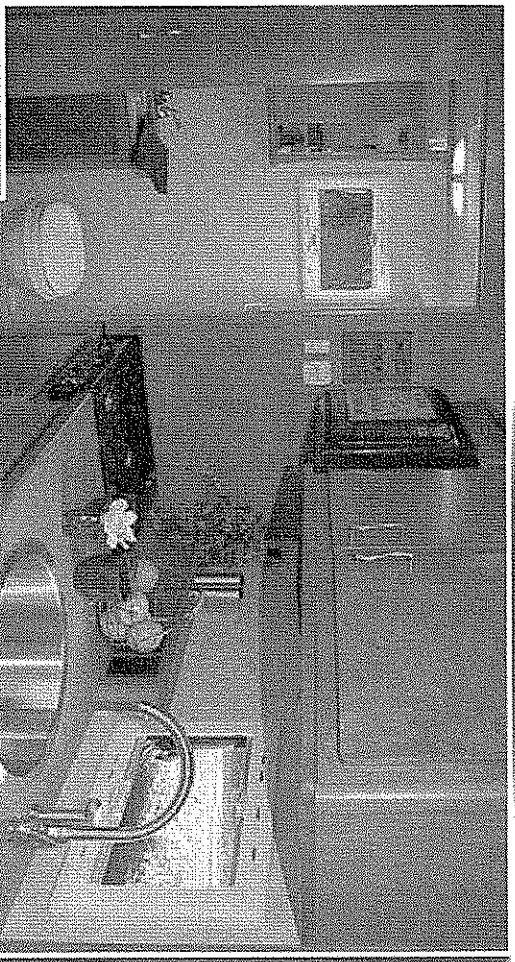

## GALLEY CONVENIENCE...

Our wide-open galley offers all the comforts of your kitchen at home. 3-burner high performance range; 2-door, 2-way refrigerator and large half time oven, you will be able to prepare any of your family's favorite meals.

## SPACIOUS LIVING...

The Mini™ is mini in name only. Spacious 6'-5" tall ceiling and 34" of headroom over the bunk provides comfort day and night. Open living area that incorporates a spacious slide room, large European windows and residential style furniture make home away from home very comfortable and functional.

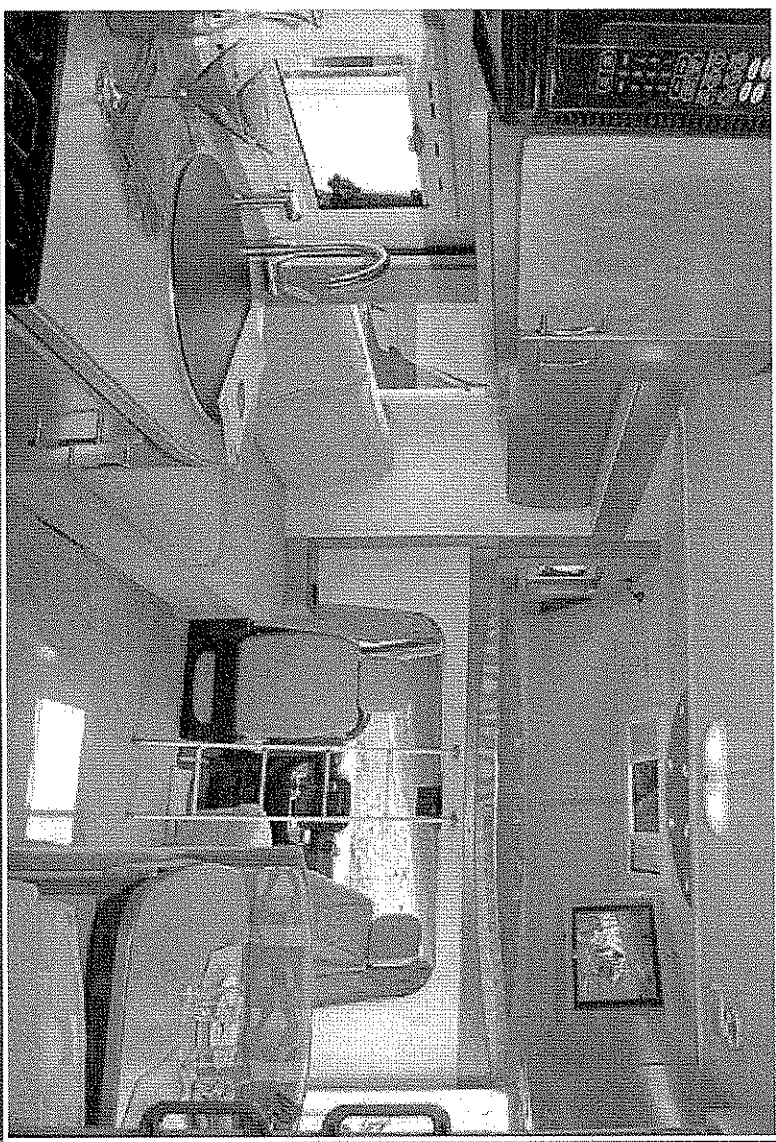

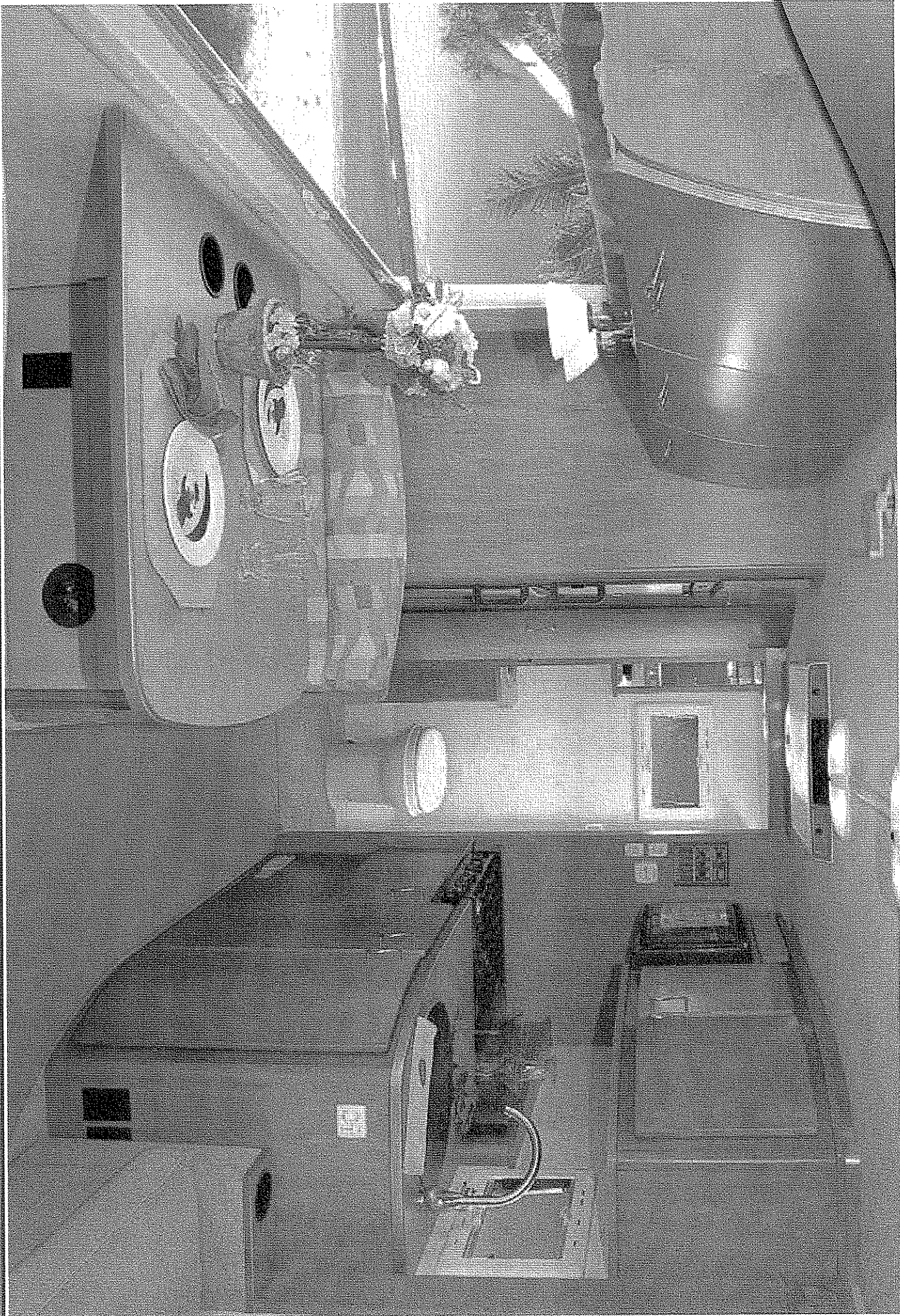

Euro-style cabinets with radius corners and faces conveniently placed for easy access creates a beautiful interior with the most usable storage in it's class.

GULF STREAM  
COACH, INCORPORATED  
FAMILY VALUE

# VISTA CRUISER



MINI

TM

## SUPER STRENGTH TRUSS SYSTEM 8" CHANNEL EXTENSION

The super strength truss system is unmatched in the industry. The structural subfloor foundation begins by Huck fastening a network of integrated steel trusses to the chassis. Specifically designed to distribute and transfer the tremendous forces from the coach to the chassis. These trusses are individually tested to withstand 4,000 pounds each.

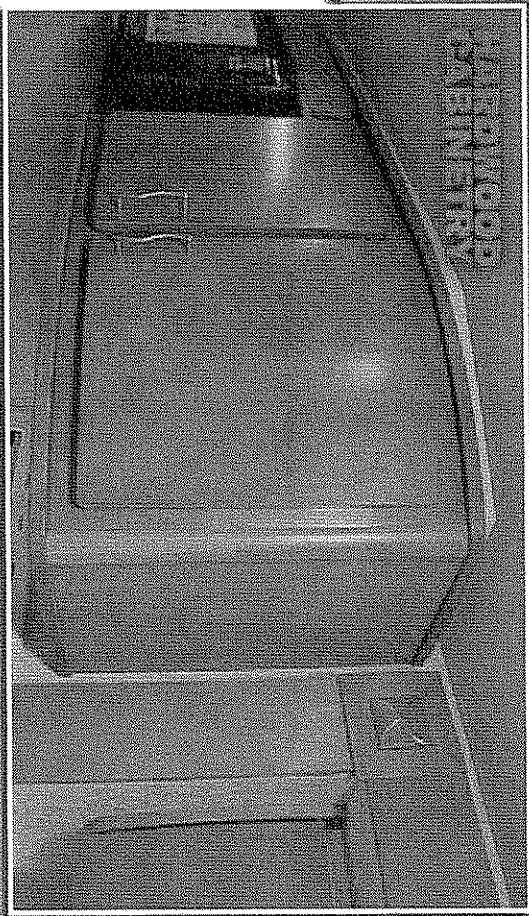

Our residential style cabinets are constructed of hardwood doors and fronts that are predrilled and screwed then they are stained and top coated with a furniture grade finish that provides long lasting beauty and durability as well as adding strength and quietness to your motorhome.

Other companies use wrapped cabinet fronts prone to peeling, fading and tearing. The softer composite wood used does not hold screws as well as hardwood resulting in loss of strength and squeaking. Discoloration will degrade the beauty and lower the value of the motorhome.

COMPETITOR'S CABINETRY

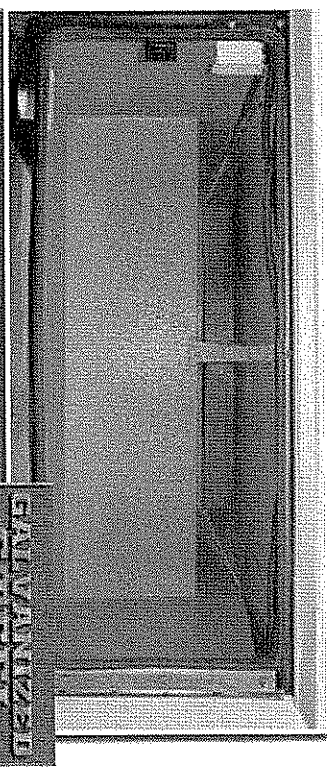

Seamless, galvanized steel storage compartments safely cradle your valuables. Rust protective, water proof Poly-Tech sealed for extended life and a quiet ride.

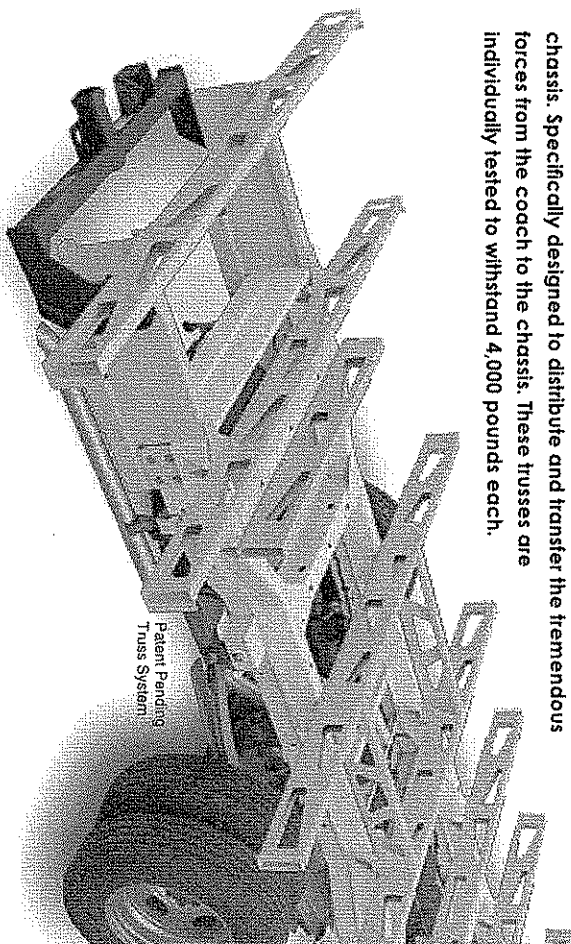

Patent Pending  
Truss System

- Excellent Weathering - Virtually impervious to sun, rain and snow Poly-Tech maintains the vehicle's quality appearance enhances its resale value.
- Tear Resistance - Unlike rubber roofing, Poly-Tech's abuse resistant textured finish resists tearing, a condition that can cause leaks and lead to expensive repair
- Low Maintenance - Eliminates the need for large amounts of sealant around several roof fixtures. Road grime can easily be removed with normal cleaning maintenance. Rubber chalking due to solar breakdown of the roof surface is eliminated, preserving the original appearance and resale value of the vehicle.
- Stain Resistance - Designed to resist staining on the roof and sidewalls to maintain a quality appearance.
- Structural Integrity - Unlike conventional EPDM rubber roof membranes, Poly-Tech is a structural component of the roof system.

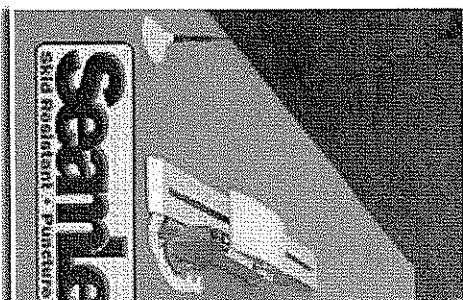

Seal-Tech  
WATER RESISTANT & PUNCTURE RESISTANT

# Cradle of Strength

## TAKE THE TIME TO COMPARE...

### You will see the exceptional value of a Gulf Stream Coach

1. Seamless Poly-Tech Spray Applied Roof For Durability and Dependability.
2. Aluminum Skin for Additional Strength.
3. Molded, High Density EPS (Expanded Polystyrene) Roof Brick Insulation - Provided Consistent Insulation Value as well as Superior Dimensional Rigidity.
4. Rugged Welded Tubular Aluminum Roof Framing.
5. Rugged Heavy-Gauge Tubular Aluminum, Fixture Welded to Form the Sidewall Framing.
6. High-Density EPS Insulation Provides Superior Lamination and Bonding Characteristics and Insures Greater Energy Efficiency.
7. Interior Wall Panels Securely Laminated to Sidewall Framing.
8. Reinforced Aluminum Skin Exterior Vacuum-bond Laminated to Sidewall Framing for Lasting Beauty and Durability.
9. Optional Custom Fib. Stain-Resistant Two Piece (Living Area, Bath) Carpet Runner.
10. Durable, Seamless Limestone Flooring.
11. Plywood Floor Decking Laminated to Steel Floor Structure Assures a Quiet, Long-lasting Rigid Floor.
12. Heavy-Gauge Tubular Steel Framing, Fixture Welded for Extra Strength and Stability.
13. Heavy-gauge Steel Box Truss System Provides the Strongest and Lightest Class C Foundation in the Industry.
14. Seamless Layer of Aluminum Securely Laminated to the Steel Floor Framing.
15. Galvanized Steel Used to Form Each Storage Compartment.
16. Seamless Spray Applied Coating Completes The Exterior of Each Storage Compartment, Protecting From Moisture and Road Debris Impacts.
17. Rust-Prohibitive Paint Coating Applied to All Steel Framing Assures Corrosion and Rust Protection.
18. The Industry's Strongest, Most Spacious Exterior Storage Compartments.

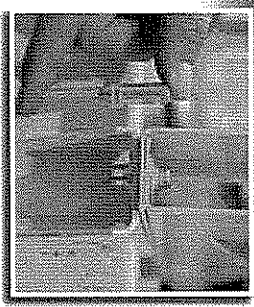
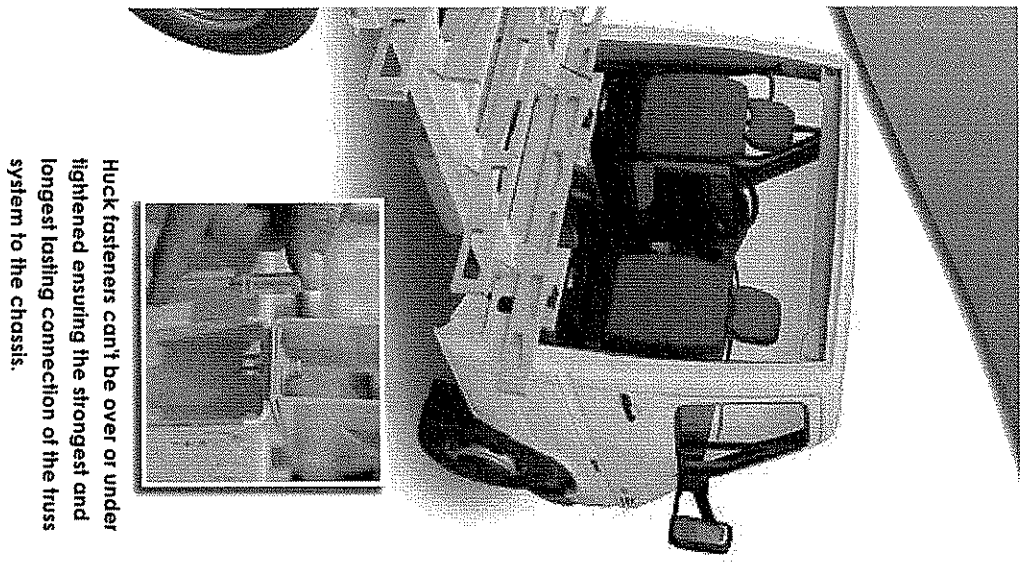

Huck fasteners can't be over or under tightened ensuring the strongest and longest lasting connection of the truss system to the chassis.

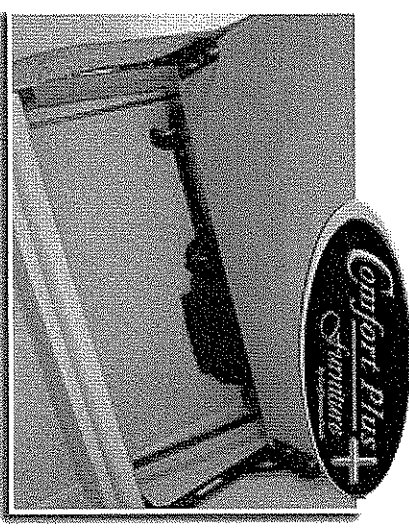
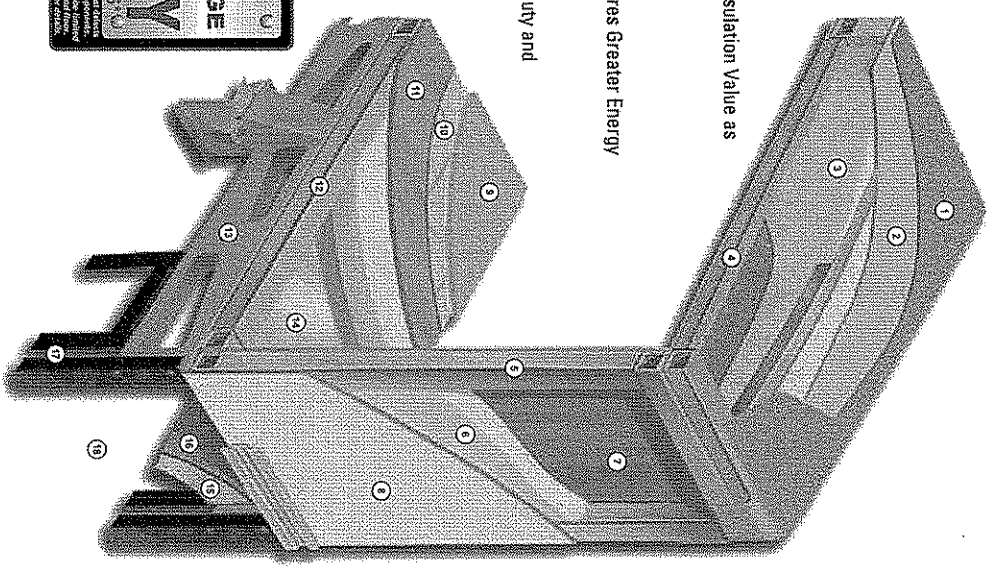
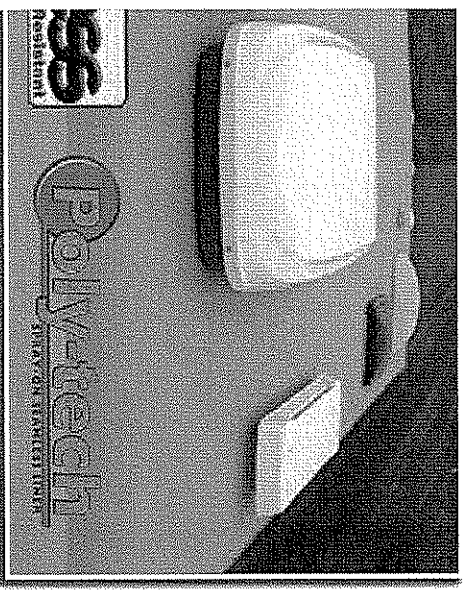

Unlike traditional plywood and foam seating Comfort Plus Seating features the strength of steel and the comfort of a sprung dinette cushion.

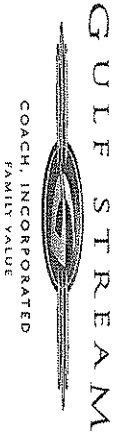
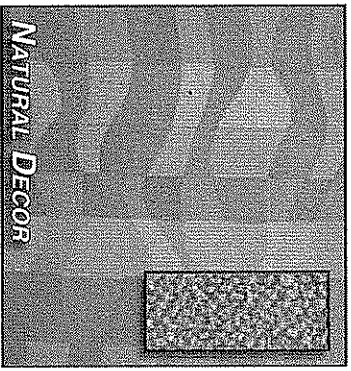
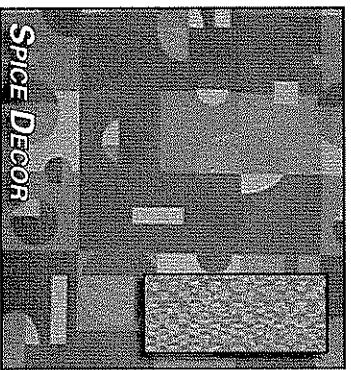
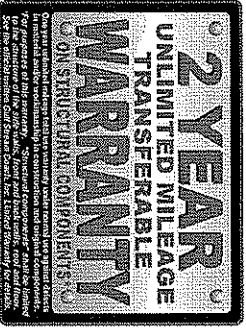

# VISTA CRUISER



Standards (4230, 4231)



All Screen

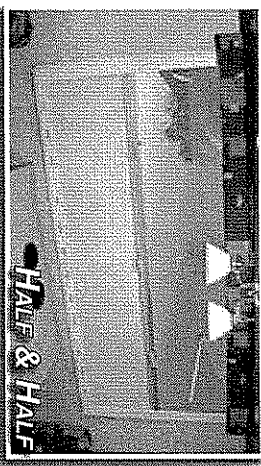

Half & Half

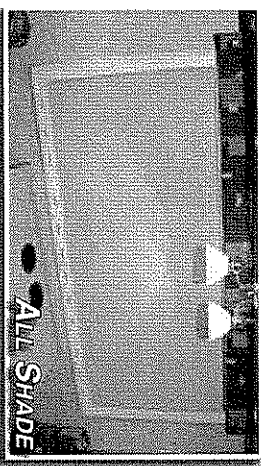

All Shade

### PICTURE WINDOWS ...

European style dual pane windows with built in shades and screens provide excellent ventilation, keep unwanted winged visitors out, let in all or as little sun as you desire and offer emergency exit just in case.

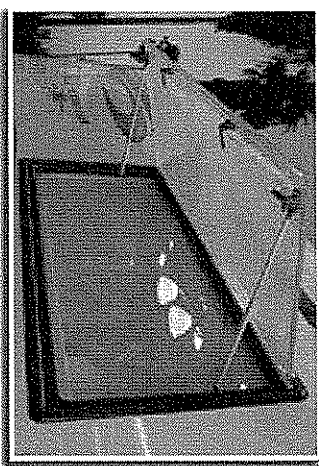

The outer pane is mounted awning style to keep light rain out and still allow the fresh air in.

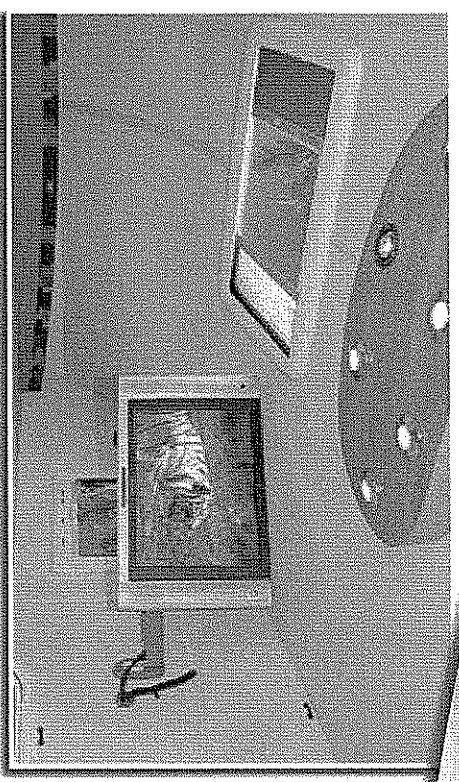

### PRACTICAL ...

Enormous overhead sleeping area that can support over a half ton with 34 inches of headroom, LCD flat panel TV that swivels for the best viewing angle and swings out of the way for storage, supersized skylight with blind, Quartz lighting with dimmer and a very clean European style that is sure to make you the envy of the grounds.

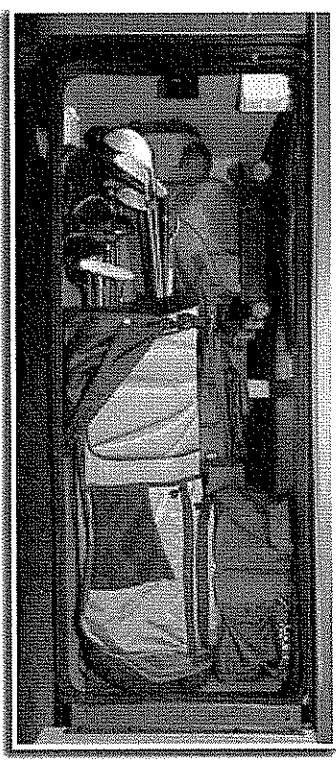

### LOTS OF STUFF ...

You have lots of stuff to take with you and we give you lots of convenient storage for all that stuff. Our Poly-Tech lined compartments keep your valuables clean, dry and secure.

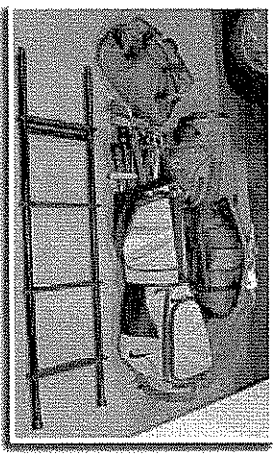

### Chassis

- C3500 SPINSTER CAB & CHASSIS
- 5 CYLINDER MERCEDES BENZ DSL CDI ENGINE
- 4 WHEEL ANTI-LOCK BRAKING SYSTEM W/ACR
- ELECTRONICALLY CONTROLLED 5-SPEED AUTOMATIC TRANSMISSION
- DRIVER & PASSENGER AIR BAGS
- AM/FM STEREO

### Heating & Cooling

- 19,500 BTU ROOF A/C
- 25,000 BTU FURNACE

### Power

- 3.6 ONAN LP GENERATOR
- (1) 24 DEEP CYCLE BATTERY

### Electrical

- 20" LCD COLOR TV
- TV ANTENNA

### Exterior

- VISTA CRUISER MINI PAINT & GRAPHICS
- FULL INTEGRATED ACRYLIC WINDOWS
- AWNING

### Furnishings

- FACTORY PILOT/CO-PILOT SEATS
- 48 X 72 JACK KNIFE SOFA
- 52 X 86 OVERHEAD BUNK
- BOOTH DINETTE

### Décor

- LINOLEUM THROUGHOUT COACH
- CUSTOM FIT CARPET RUNNER

### Appliances

- 3-BURNER RANGE TOP
- CONVECTION MICROWAVE OVEN
- 6 GAL WATER HEATER
- 12 GAL LP GAS TANK
- LP GAS LEAK DETECTOR
- CARBON MONOXIDE DETECTOR
- SMOKE DETECTOR
- DOMESTIC REFRER

### Plumbing

- STEP TUB W/BI-FOLD SHOWER DOOR
- POWER ROOF VENT IN BATH
- COMMODE
- 31 GAL FRESH WATER TANK
- 34 GAL BLACK HOLDING TANK
- 33 GAL GRAY HOLDING TANK

### Miscellaneous

- FIRE EXTINGUISHER
- FLOOR MATS
- TRAILER HITCH

### Popular Options

- HEATED HOLDING TANKS
- BACK UP MONITOR
- CANADIAN CHASSIS

**CoachNet®**

24 HR. EMERGENCY ROADSIDE ASSISTANCE

- One Year Coach-Net Membership
- Towing and Wreching
- Flat Tire Change
- Mobile Mechanics
- Delivery of emergency Fluids
- Jump-Start / Battery Boost
- Lockout

GULF STREAM  
COACH, INCORPORATED  
FAMILY VALUE

# MODEL 4230

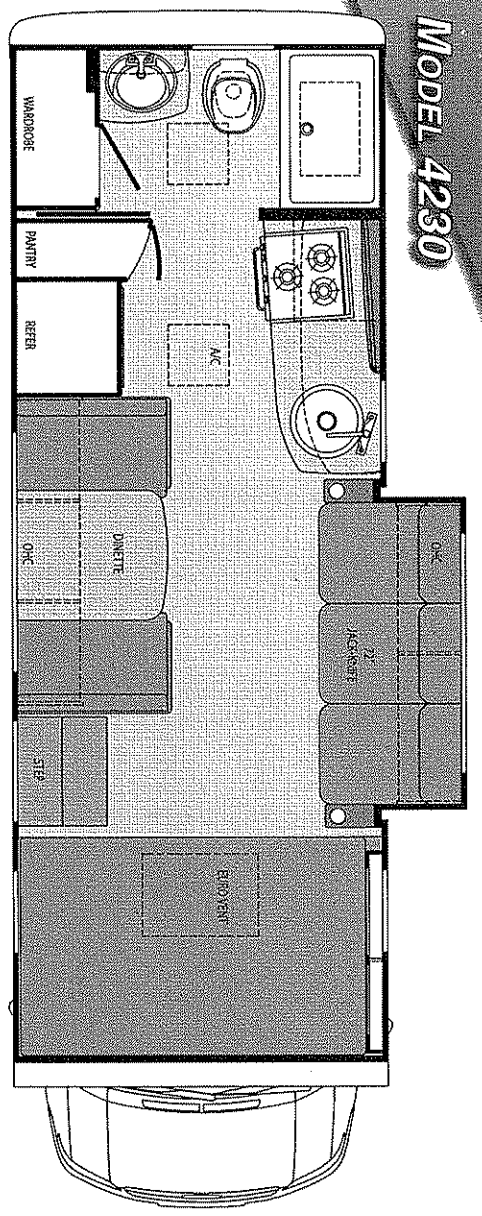

# MODEL 4281

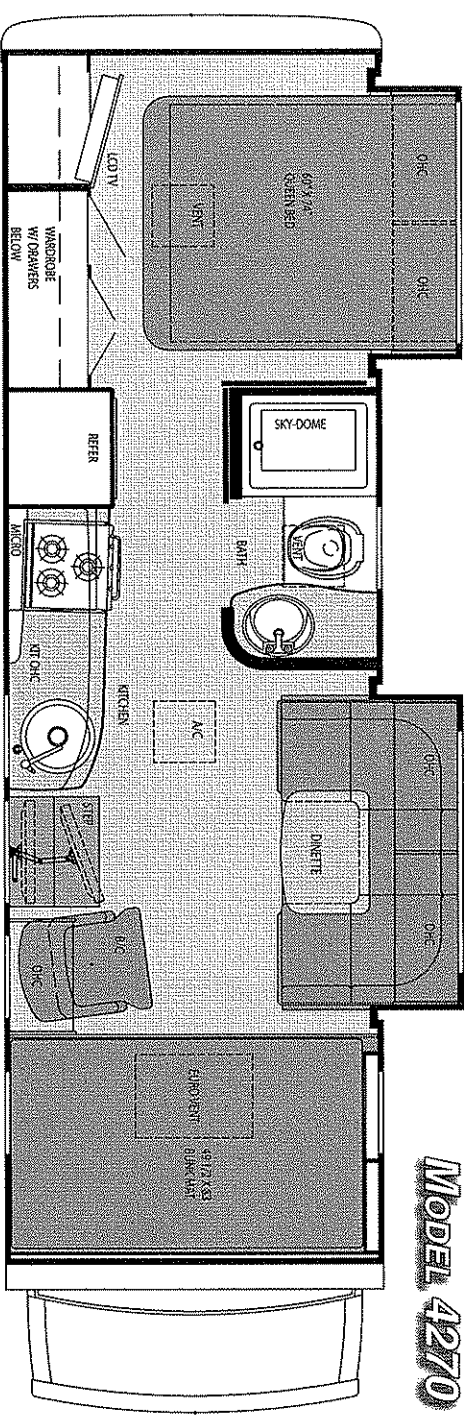
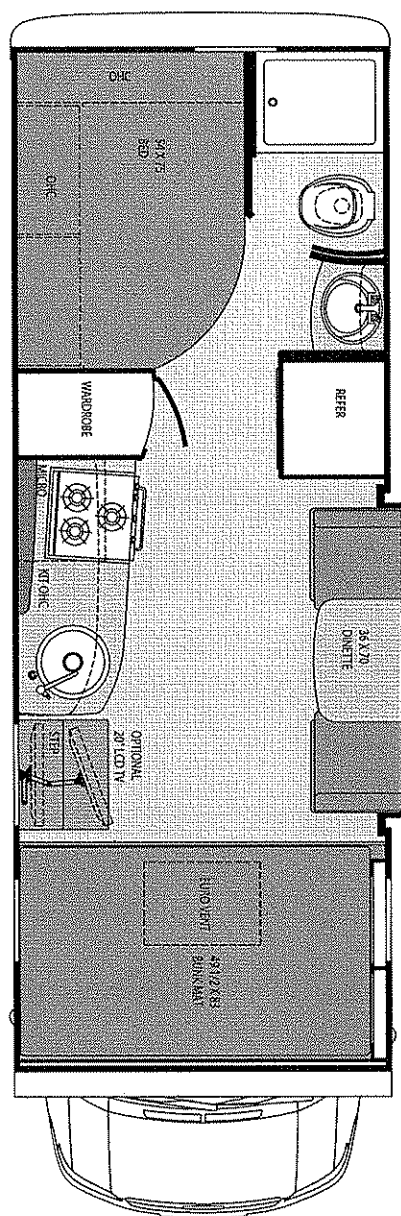

# MODEL 4270 - FORD E450 DIESEL

## Specifications

Chassis	Freightliner
Engine	2.7 Liter 5-cylinder Mercedes Benz, Turbocharged Diesel
Horsepower	154 HP @ 3,800 RPM
Torque	243 ft. lbs. @ 1,600 - 2,400 RPM
GVWR	10,200
Wheelbase	158"
Exterior Length	23' 10"
Exterior Height	10' 7"
Exterior Width	7' 7"
Interior Height	6' 5"
Interior Width	7' 4"
Fuel System	CDI (Common Direct Rail Injection)
Transmission	Mercedes Benz 5-speed Automatic Transmission w/Overdrive
Steering	Power Assisted Rack and Pinion
Suspension	Independent Front Suspension
Brakes	4-wheel Hydraulic Disc with ABS
Body Type	Reinforced Aluminum Skin Vacuum Bond Laminated
Air Bags	Driver and Passenger Side Airbags
Maintenance	Service Intervals of 10,000 miles
Protection	Anti-Theft Detourment Security System (USP Immobilizer)
Fresh	31 Gallon
Gray	33 Gallon
Black	34 Gallon
Water Heater	6 Gallon
Fuel Tank	26 Gallon
Fuel Economy	Approx 17 - 19 Mpg.
LP Gas Tank	48 Lbs. (12 gallon)
Generator	3.6 Onan
A/C	13,500 BTU
Furnace	25,000 BTU
Amp Service	30 Amp Service w/ 30 Amp Converter
Rear Axle Ratio	4.11 (Recommended for frequent use in hilly regions or for towing)
Towing	3,500 LB Capacity

Chassis	Ford E450
Engine	V8 Diesel
Fuel	55
GVWR	14,050
Wheelbase	196"
Length	27'-7"
Height w/A/C	18D
Width	91"
Interior Height	78"
Black	18D
Grey	18D
Fresh	18D
LP Gas Tank	42 lbs.
Furnace (BTU's)	25,000
Water Heater w/DSL	6 gal.
Ext Storage	18D

DEDICATED TO QUALITY,  
INNOVATION AND  
VALUE.

VISTA CRUISER  
MINI

### Gulf Stream Coach

has been a manufacturer of recreational vehicles for over 20 years. Our slogan, "Family Value," speaks to our family-owned company, the value offered in our products and to our customers.

We use advanced manufacturing techniques to build everything from entry-level travel trailers to luxury motorhomes. We offer the largest product line in the industry.

RV dealers and consumers look to Gulf Stream for high-value products offering quality construction, innovative features, contemporary design, unmatched service and on-going support.

We'd love to have you as part of the family



The Gulf Streamers RV Club is a valuable benefit to all Gulf Stream owners. Members enjoy shopping, activities and participating in the various rallies and caravans offered throughout the United States and Canada. The Motor Stream, the club magazine, with up-to-date product information, service tips and company highlights. Members benefit from the Emergency Road Service and Gulf Streamer Insurance options. Both are available at competitive rates with friendly reliable service. The 10% discount program at campgrounds throughout the U.S. and Canada. As a member, you'll receive discounts at National Theme Parks and special attractions, including RV and travel guides, brochures and magazines. Gulf Streamers spend time touring attractions, enjoying fabulous meals, taking in area highlights and stops to help make the most out of your RV experience. Special rallies throughout the year include Gulf Stream supplier seminars, complimentary minor repairs by Gulf Stream technicians, Gulf Stream dealer product displays and round table discussions to voice your product improvement ideas.

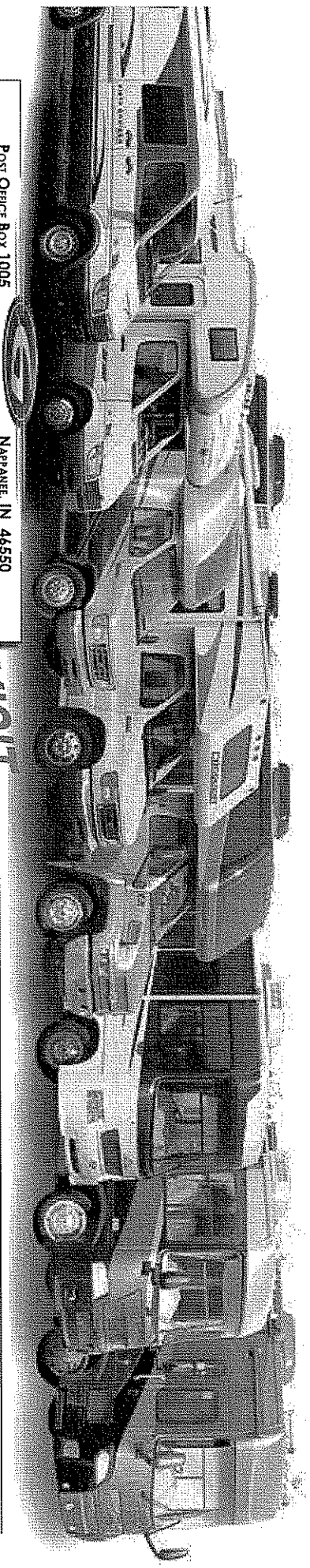
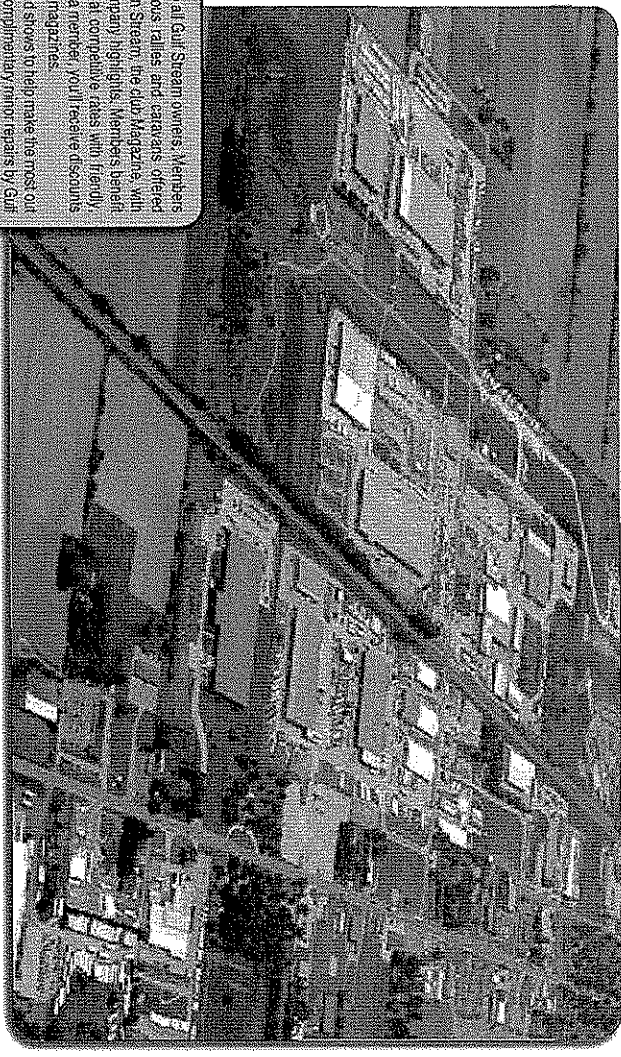

Post Office Box 1005  
• Your Gulf Stream Coach Dealer •  
NAPPANEE, IN 46550

VISIT

WWW.GULFSTREAMRV.COM 1-800-765-8787-EXT. 3288

OR CALL

For more information and available options, contact your local Gulf Stream dealer, [www.gulfstreamrv.com](http://www.gulfstreamrv.com) or Gulf Stream Coach, Inc. Gulf Stream Coach, Inc. reserves the right to make changes in prices, colors, materials, components or specifications and to discontinue models at any time without notice or obligation. Gulf Stream Coach, Inc. assumes no responsibility for any error in type or print reproduction, specifications or illustrations in this brochure. Photographs may show equipment or items that are optional and are not included in the purchase price of the coach. Test drive and review a current model at your nearest Gulf Stream dealer. © 2002 Gulf Stream Coach, Inc., Nappanee, Indiana U.S.A. 8/06-SF-15K Ver1